



SLAT KIT PLATFORM BED

ATLANTIC FURNITURE

ASSEMBLY INSTRUCTIONS

(KING E-65503)

Before assembling your Bed slat kit, please read through these instructions carefully. Familiarize yourself with the different parts. Please note that you will require a Phillips Head Screwdriver and an Allen wrench.

ATTENTION! If you receive a damaged or defective item, please contact Atlantic Furniture at service@atlanticfurniture.com 1-800-955-3726 / M-F 9:00-5:00 EST

PARTS LIST

01	SLAT KIT	3 SET
02	CENTER RAIL	3 PCS
03	TALL CENTER LEG	6 PCS
04	SHORT CENTER LEG	6 PCS

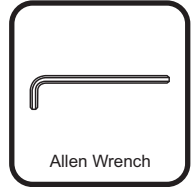
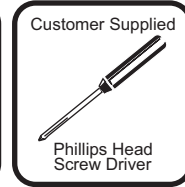

NOTE: WE INCLUDE SPARE HARDWARE IN CASE THE ALLEN WRENCH, ALLEN SCREW OR WOOD SCREW ARE DAMAGED DURING ASSEMBLY.

HARDWARE



A 1 1/2" Allen Screw - 12 pcs
Spare - 2 pcs

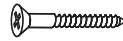

B 1 1/4" Wood Screw - 12 pcs
Spare - 2 pcs

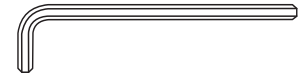

C Allen wrench - 1 pc
Spare - 1 pc

Step 1

Assemble bed frame according to bed assembly instructions.
If using mattress and foundation set the bed up low and use short center leg.
If using bed drawer choose the tall center leg.

Step 2

Assemble center leg (03 / 04) and center rail (02) using allen screw (A).
Tighten with the allen wrench (C).
Repeat for other center rail.

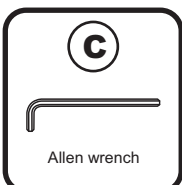
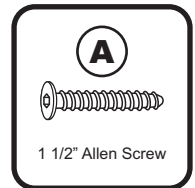
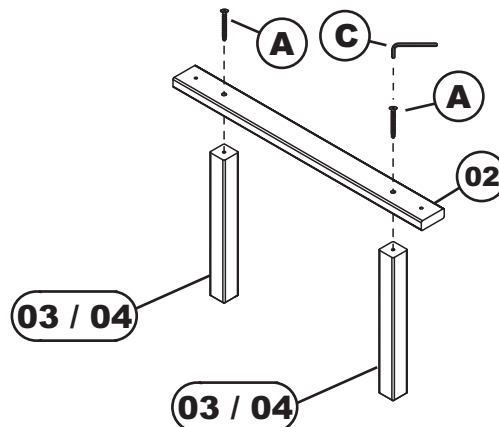

Step 3

Lay the slat kit (01) onto the bed.

Attach center rail assemble (02) to slat kit (01) using allen screw (A), tighten with the allen wrench (C). Repeat for section 2 and 3.

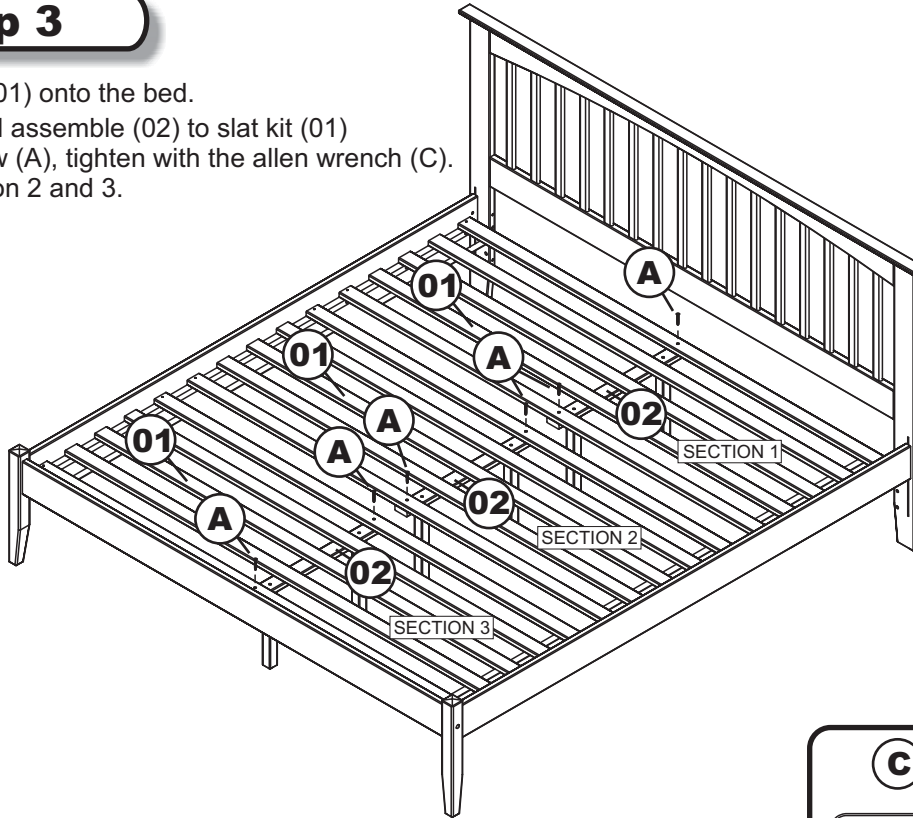

Adult Assembly

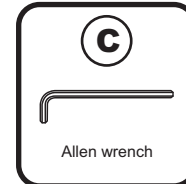

Allen wrench

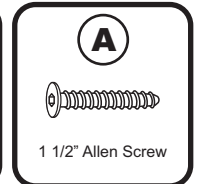

1 1/2" Allen Screw

Step 4



Adult Assembly



1 1/4" Wood Screw



Customer Supplied

Phillips Head
Screw Driver

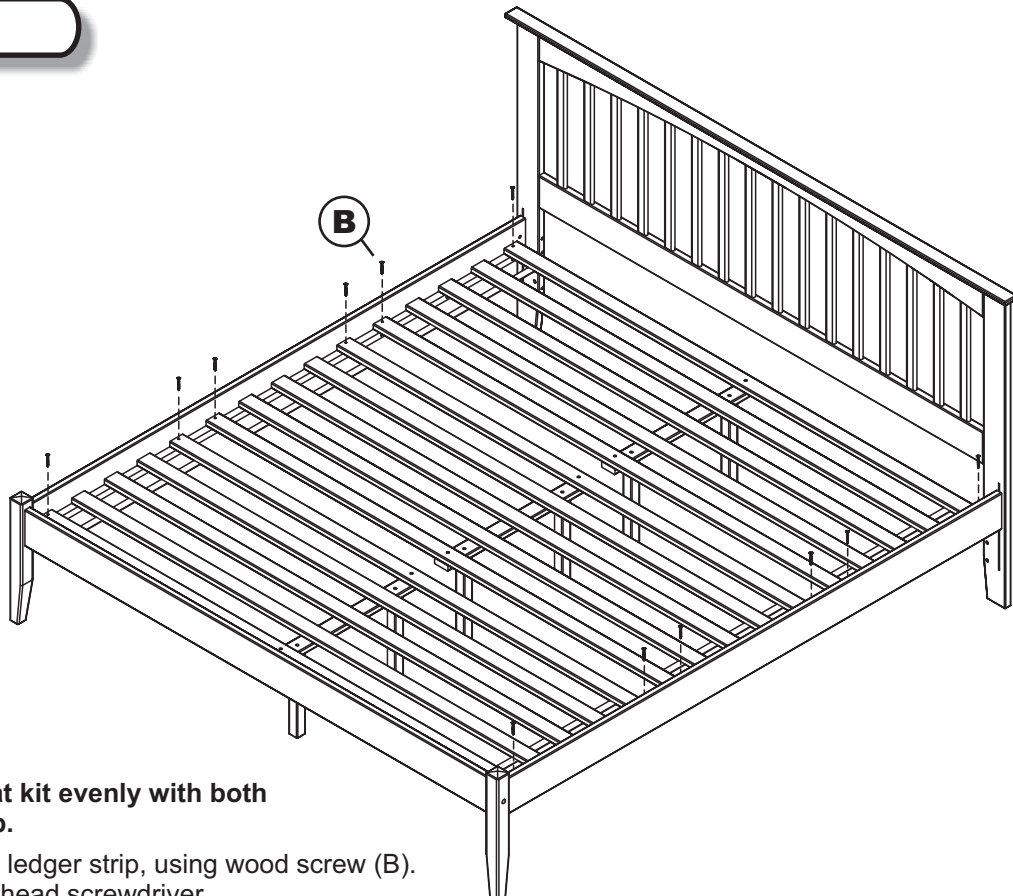

Be sure to align slat kit evenly with both ends of ledger strip.

Screw slat kit (01) to ledger strip, using wood screw (B). Tighten with Phillips head screwdriver. Be sure the space between slats is even.