

Assembly Instructions For

F2745/4

(E) 11/11

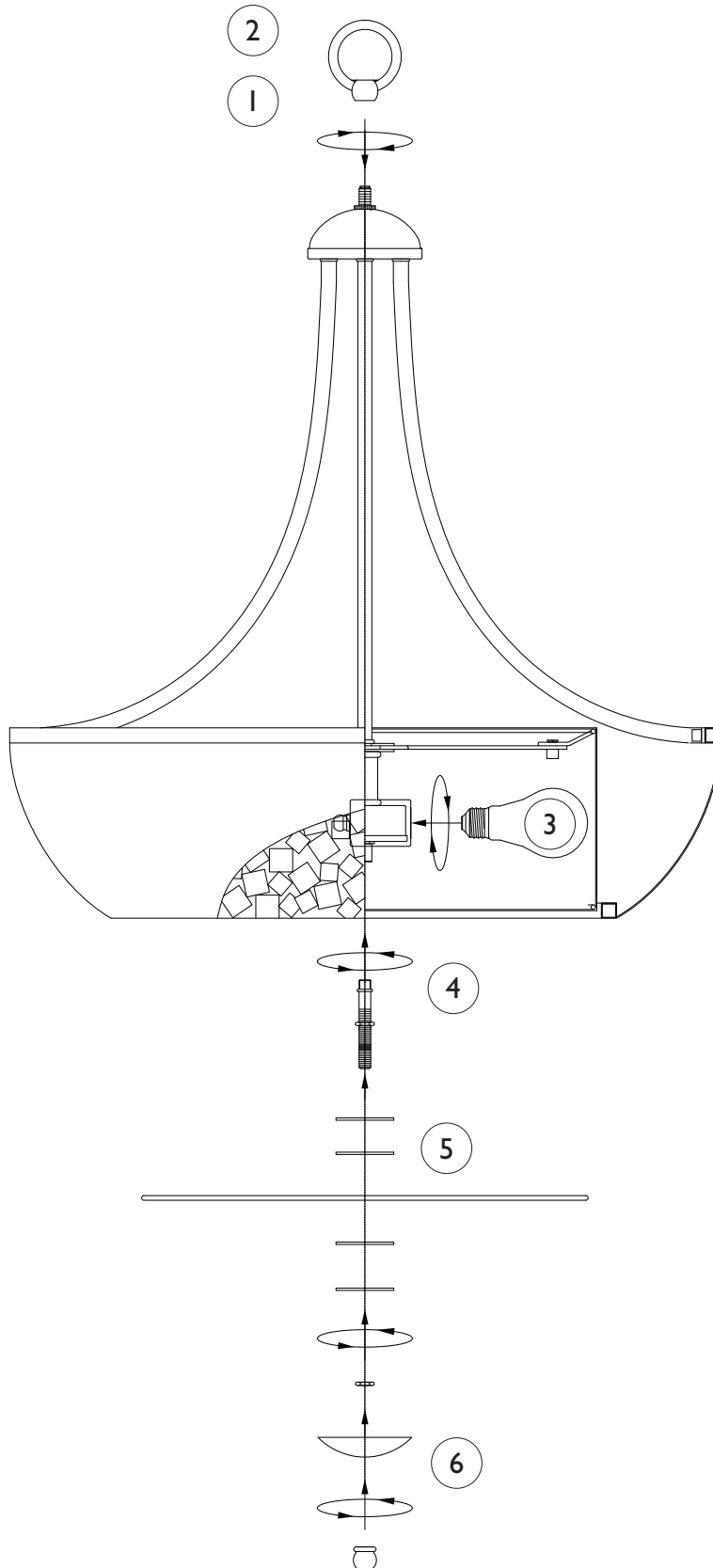

IMPORTANT
TURN OFF THE POWER AT THE MAIN FUSE
OR CIRCUIT BREAKER BOX
BEFORE STARTING INSTALLATION

Carefully unpack and identify all parts before assembly. Bulbs not included.

1. Install the fixture loop onto the top of the fixture.
2. Follow enclosed supplement installation instructions for electrical and fixture installation onto house outlet box. If you do not have an outlet box at desired location to attach the fixture then hire a qualified electrician to create one.
3. Install light bulb (not included). See relamping label at socket area for type and maximum allowed wattage.
4. Install the threaded pipe onto the socket assembly as shown.
5. Raise the glass plate and slip it through the installed threaded pipe. Secure the glass plate with the washers and hex nut.
6. Then place the cover onto the threaded pipe below the glass plate and fasten it into place using the finial.

