

WARNING:

READ ALL WARNING & SAFETY INSTRUCTIONS BEFORE ASSEMBLING PRODUCT. KEEP INSTRUCTIONS FOR FUTURE USE.

Storage: The product must be kept in a dry and clean area.

Care and Cleaning: Do not scratch or chip the finish. Do not use abrasive chemicals for cleaning. Clean with mild soap on a soft rag. Rinse and dry thoroughly. If you choose to refinish this furniture, be sure to use only a non-toxic finish specified for children's products.

WARNING

FALL HAZARD – TO PREVENT DEATH OR SERIOUS INJURY ALWAYS KEEP CHILD WITHIN ARM'S REACH.

- NEVER LEAVE THE CHILD UNATTENDED.
- SECURE THE CHILD IN THE RESTRAINT WHEN USING CHANGER.
- KEEP THE CHILD IN VIEW WHILE CHILD IS IN THE CHANGER.
- STOP USING THE CHANGER WHEN THE CHILD IS ABLE TO SIT UP OR ROLL OVER.
- PERIODICALLY CHECK FOR LOOSE OR WORN PARTS, TIGHTEN, REPAIR, OR REPLACE AS NEEDED.
- THIS PRODUCT IS FOR RESIDENTIAL USE ONLY. ANY INSTITUTIONAL USE IS STRICTLY PROHIBITED.
- CAN ONLY RETAIN CHILD WITH MAXIMUM WEIGHT UP TO 30 LBS.
- ALWAYS SECURE CHANGING PAD TO THE CHANGER SURFACE BY FASTENING THE BELTS.
- DO NOT USE CHANGING TABLE, ADD-ON CHANGING UNIT, OR CONTOURED CHANGING PAD IF IT IS DAMAGED OR BROKEN.
- THIS PRODUCT IS NOT INTENDED TO BE USED AS A CHANGING TABLE WITHOUT FASTENING THE SAFETY BELT. USE OF THE PRODUCT WITHOUT THIS MAY RESULT IN DEATH OR SERIOUS INJURY TO YOUR CHILD FROM FALLING. FOLLOW ALL INSTRUCTIONS ON ATTACHING AND USING THE SAFETY BELT.
- RECOMMEND PAD SIZE 34" x 17" x 1".

PARENT SHOULD ENSURE A SAFE ENVIRONMENT FOR THEIR CHILD BY CHECKING THE FURNITURE CAREFULLY BEFORE PLACING CHILD IN THE PRODUCT. PLEASE MAKE SURE EVERY COMPONENT IS PROPERLY AND SECURELY IN PLACE.

WARNING

IMPORTANT SAFETY NOTICE

This or any changer unit can tip or fall over for when not used for its intended purpose. This could potentially result in serious injury or death.





Keep your children and others safe by following these simple rules:

- Do not allow climbing on any changer unit.
- Do not leave drawers open when not in use.
- Do not allow standing in drawers
- Do not allow hanging from drawers.
- Do not allow standing on top of changer unit.
- Do not place heavy objects in drawers.
- Do not place heavy objects on top of the changer unit which can be pulled down on top of your child.
- To avoid head injury, do not allow your child to play underneath open drawers.
- Child must be securely fastened to changer unit when the unit is in use.
- Always monitor your child's activity when in the nursery.



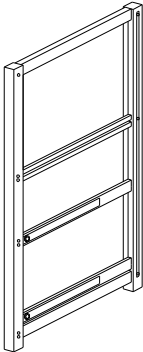
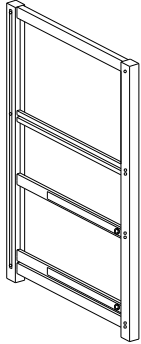
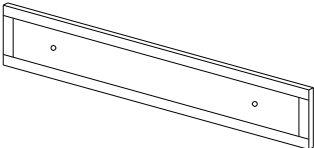
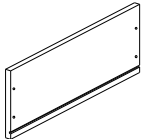
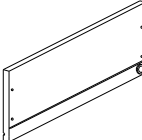
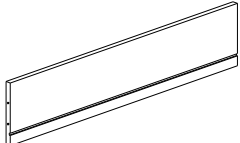
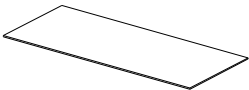
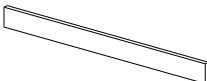

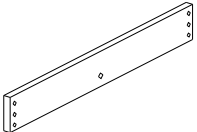
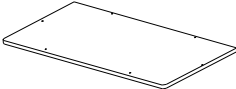
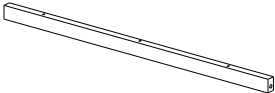
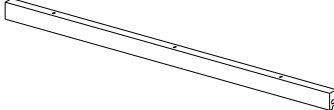
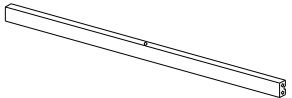

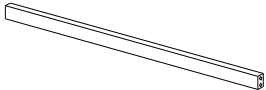
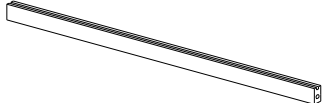
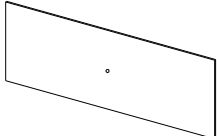
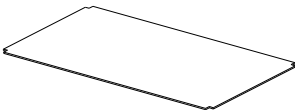
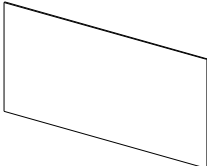
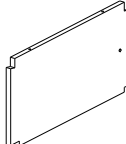

M008 Changer Parts Identification Sheet

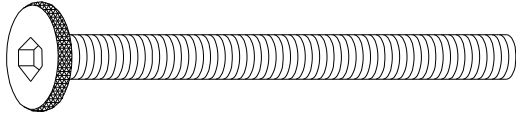
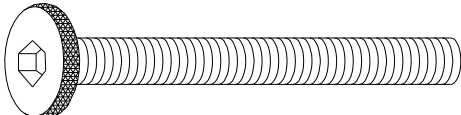
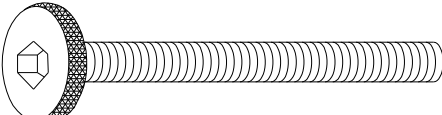
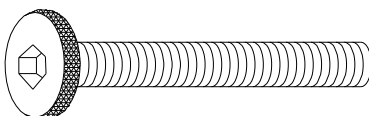
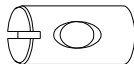
DO NOT assemble changer if parts and hardware are defective or missing.
Contact AFG for exchange or keep the original box for return authorization.

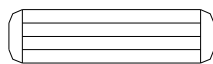
~ Changer Assembly Parts

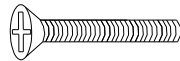
<p>A. Left Side Panel (1 pc)</p> 		<p>B. Right Side Panel (1 pc)</p> 	
<p>C. Drawer Front Panels (2 pcs)</p> 	<p>D. Drawer Left Panels (2 pcs)</p> 	<p>E. Drawer Right Panels (2 pcs)</p> 	<p>F. Drawer Back Panels (2 pcs)</p> 
<p>G. Drawer Bottom Panels (2 pcs)</p> 	<p>H. Top Front Panel (1 pc)</p> 	<p>I. Top Back Panel (1 pc)</p> 	<p>J. Top Side Panels (2 pcs)</p> 
<p>K. Top Panel (1 pc)</p> 	<p>L. Upper Front Rail (1 pc)</p> 	<p>M. Upper Back Rail (1 pc)</p> 	<p>N. Front Shelf Rail (1 pc)</p> 
<p>O. Back Shelf Rail (1 pc)</p> 	<p>P. Front Drawer Rails (2 pcs)</p> 	<p>Q. Back Drawer Rail (1 pc)</p> 	<p>R. Upper Back Panel (1 pc)</p> 
<p>S. Shelf (1 pc)</p> 	<p>T. Lower Back Panel (1 pc)</p> 		<p>U. Shelf Divider (1 pc)</p> 

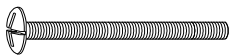
~ Changer Assembly Hardware

Item #	Fittings	Qty
1. Bolt 1/4" x 2-1/2"		(14 pcs)
2. Bolt 1/4" x 2-1/4"		(6 pcs)
3. Bolt 1/4" x 2-1/4"		(4 pcs)
4. Bolt 1/4" x 1-3/4"		(1 pc)
5. Barrel Nut 1/4" x 15 mm		(14 pcs)
6. Barrel Nut 1/4" x 13 mm		(11 pcs)
7. Dowel 8mm x 30 mm		(17 pcs)
8. Screw F4 x 25 mm		(16 pcs)
9. Machine Screw 3/16" x 1"		(6 pcs)
10. Knob		(4 pcs)
11. Bolt 5/32" x 3/4"		(4 pcs)
12. Wrench		(1 pc)

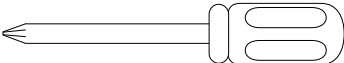
PHILLIPS SCREWDRIVER   (NOT INCLUDED)

M008 Changer Parts Diagram

Please follow this Parts Diagram to make sure that all parts are assembled in the correct position.

~ Changer Drawer

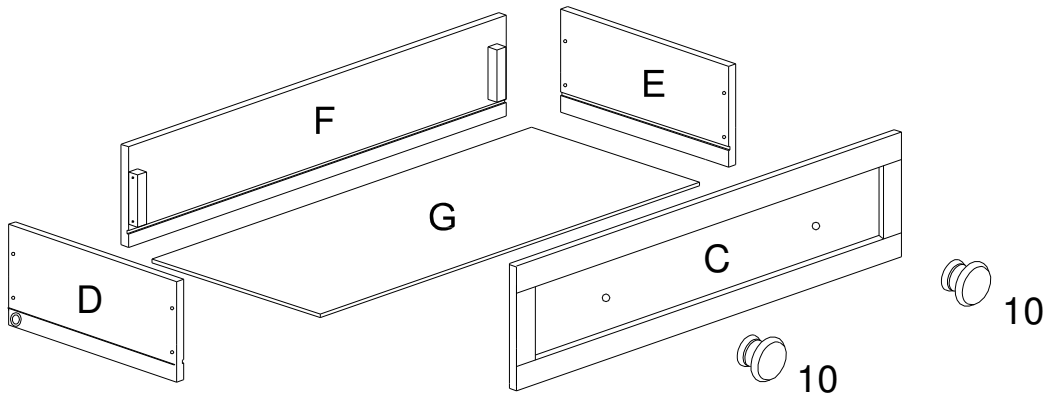

C.	Drawer Front Panel	(1 pc)	D.	Drawer Left Panel	(1 pc)
E.	Drawer Right Panel	(1 pc)	F.	Drawer Back Panel	(1 pc)
G.	Drawer Bottom Panel	(1 pc)	10.	Knobs	(2 pcs)

~ Changer Top

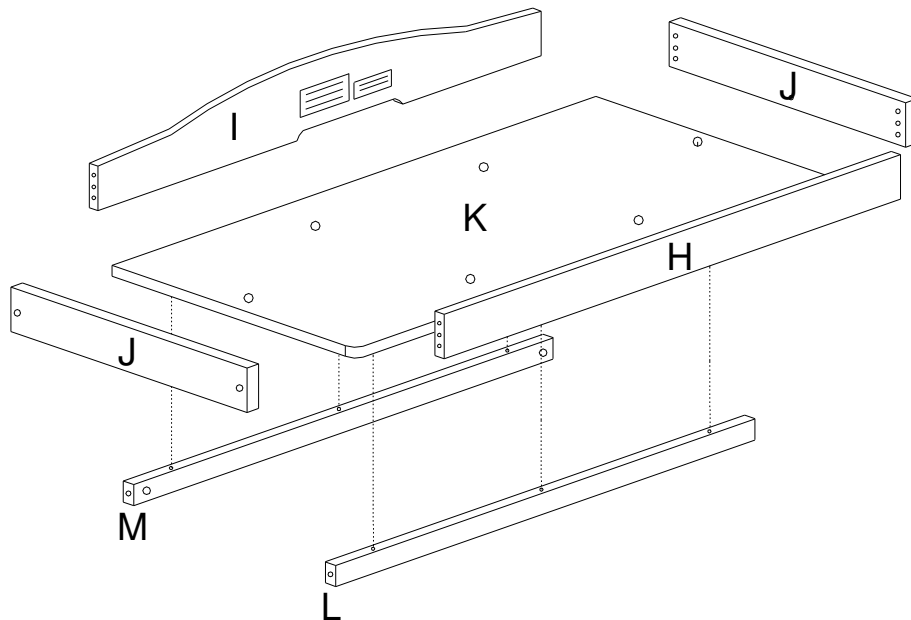

H.	Top Front Panel	(1 pc)	I.	Top Back Panel	(1 pc)
J.	Top Side Panels	(2 pcs)	K.	Top Panel	(1 pc)
L.	Upper Front Rail	(1 pc)	M.	Upper Back Rail	(1 pc)