



MODEL : YPH2498VF SERIES

- SINGLE HANDLE VESSEL FAUCET
- Finishes: BN -Brushed Nickel
ORB -Oil Rubbed Bronze
PC -Polished Chrome

● STANDARDS



FLOW RATE CHART

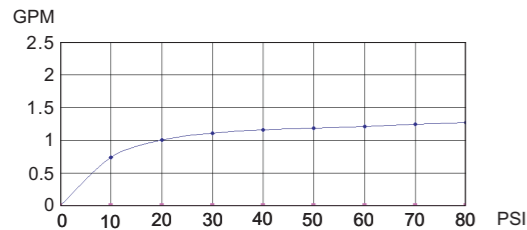

Warranty Information

Yosemite Home Décor Faucets are covered by a manufacturer's limited "lifetime" warranty for manufacturing defects.

Yosemite Home Décor Faucets have been manufactured under the highest standards of quality and workmanship. Yosemite warrants to the original consumer purchaser of the faucet against defects in material and workmanship for a period of ten (10) years from date of purchase. This warranty applies only to the original owner, providing the product has been installed in accordance with our installation instructions, used as recommended and in a normal residential application. In the event of a warranty claim, the owner will be required to provide proof of purchase - save sales receipt. This warranty covers all components which make the product operational. Yosemite Home Décor at its option, may repair or replace the product or components necessary to restore the product to good working condition. Yosemite reserves the right to inspect the installation prior to the actual replacement of the product or component part. This warranty does not cover misuse or abuse, accidental damages, scuffs or scratches, improper installation, abnormal usage, negligence or damage caused by improper maintenance or cleaning.

** Normal wear of parts is excluded from the warranty. Damage caused by impurities or acts beyond our control are not covered. Any replacement excludes transportation and any labor re-installation costs.

This warranty does not allow recovery of incidental or consequential damages such as loss of use, delay, property damage or other consequential damage, and Yosemite Home Décor accepts no liability for such damages.

The Yosemite Home Décor warranty is limited to the above conditions and to the warranty period specified herein and is exclusive. Yosemite Home Décor disclaims all other warranties, expressed or implied, including implied warranties of merchantability and/or fitness for a particular purpose.

Pre- Installation reminders

Check with the local plumbing code requirements before installation

Gather necessary tools needed for installation. Some may not be needed depending on the model of the faucet being installed.

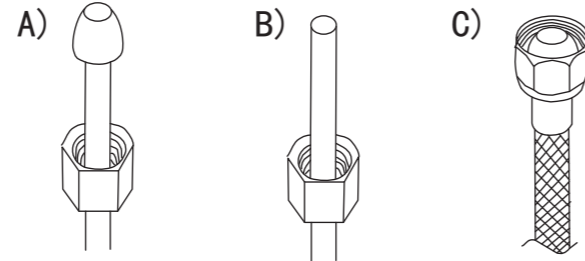

- (A) 3/8" supply lines with coupling knots;
- (B) 3/8" supply lines with interior connectors;
- (C) 1/2" IPS faucet connector.

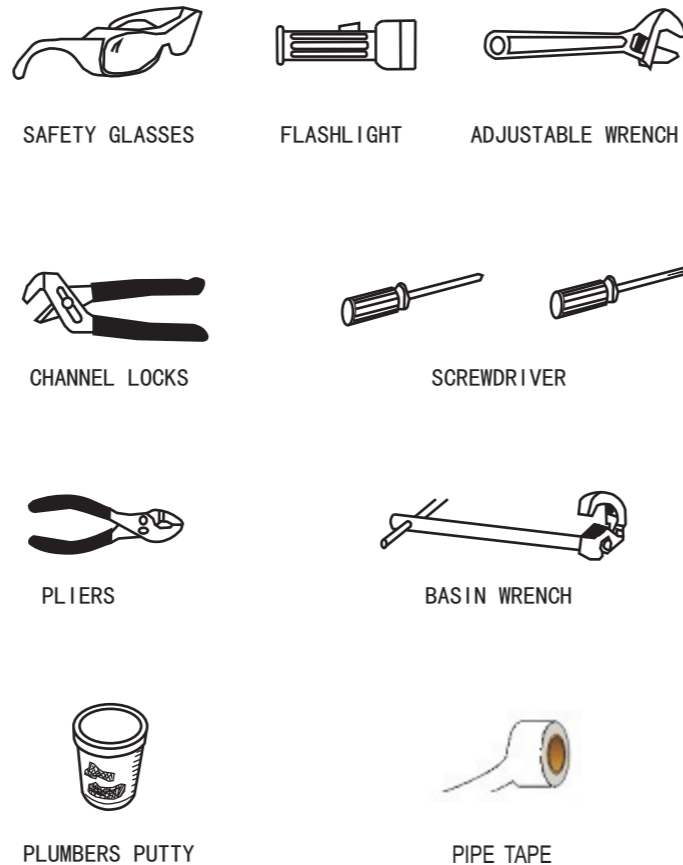

Procedures for Faucet Installation

Yosemite Home Décor always recommends that plumbing products be installed by a certified professional.

Important:

Remove the aerator and let both hot and cold water run for one minute. This will help clean any debris that might otherwise clog the system. Replace aerator.

Test system for leak.



Maintenance:

Simply rinse the surface with clear water or mild liquid detergents (if necessary). Dry the faucet with a clean soft cotton cloth. Do not use any cleaning agents containing acids, polish abrasives, or harsh cleaners.

Configuration

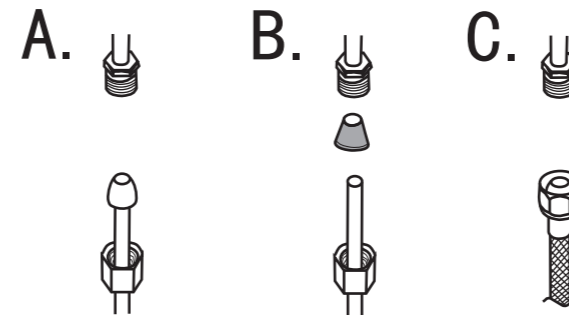

- Connect to water supply lines with either:
- (A) 3/8" O. D. copper tubing (ball nose risers with the coupling nuts or;
 - (B) 3/8" copper tubing (no ball) with supplied tube head interior connector or;
 - (C) IPS faucet connectors (1/2").

Check for leaks

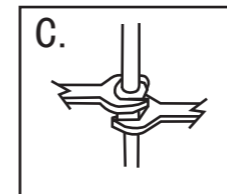

Important
Tighten connection with two wrench to prevent damage to tube body. Be careful not to bend the stem as this will void the product warranty.

YPH2498VF

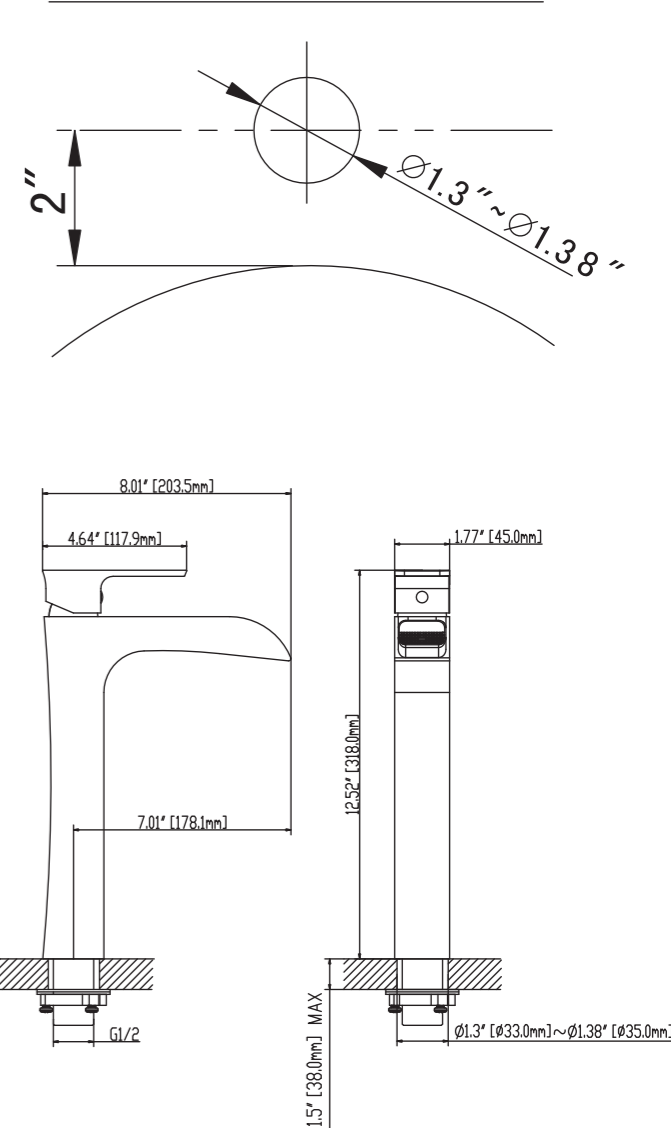

Installation

YPH2498VF

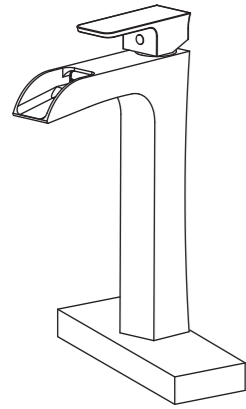

1

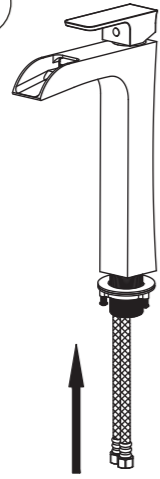

Installed and tighten the hose by hand.

5

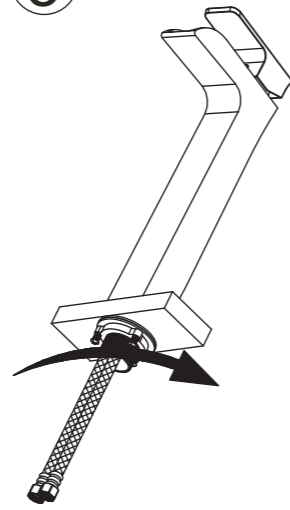

6

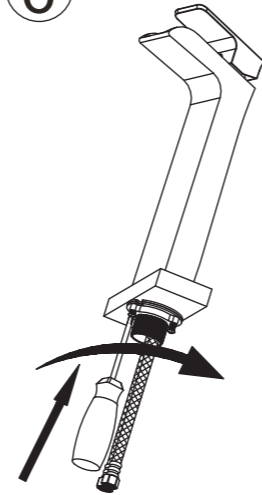

2

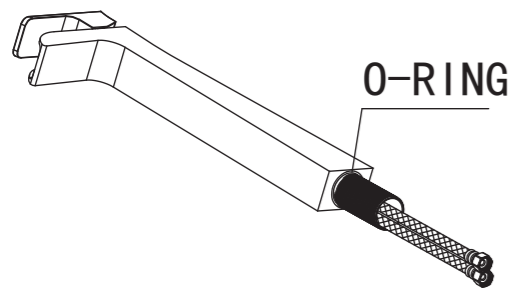

O-RING

7

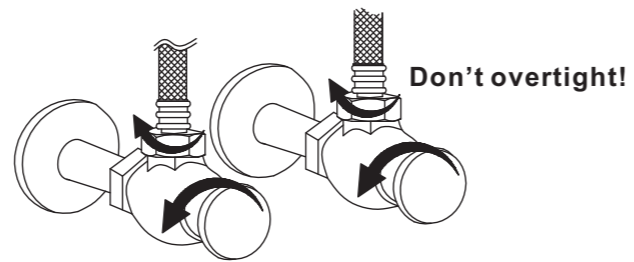

Don't overtight!

3

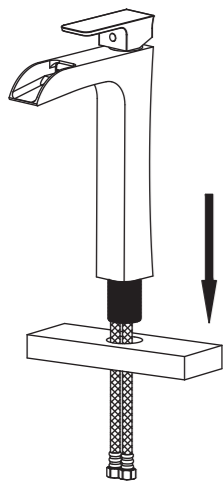

4

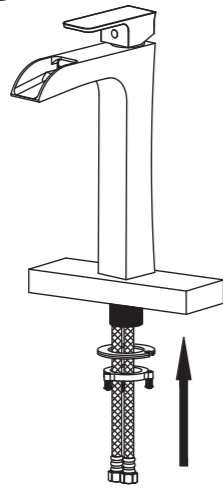

Maintenance

If there is splash or low flow rate, please remove the aerator by aerator wrench and clean the debris.

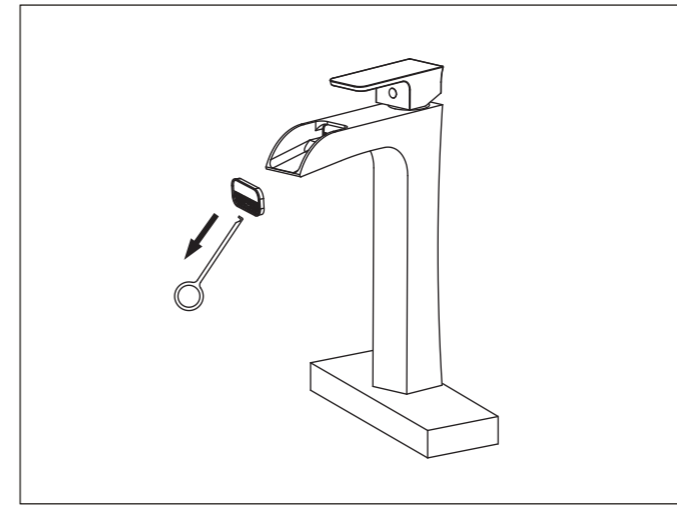

3

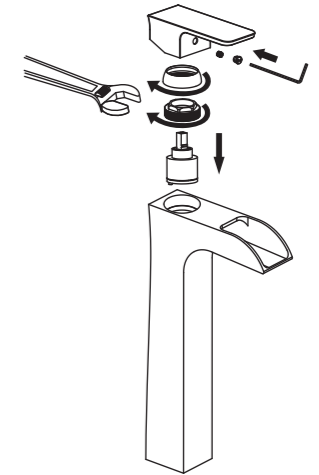

If faucet leaks from the handle or drips from spout, please replace cartridge following the following steps:

1

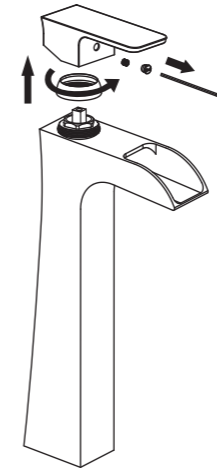

2

