

**G6451/G6452  
Youth Couch Red/Blue  
Assembly Instructions**

For ages 3 and up. Adult assembly required.

**⚠ WARNING**  
Small parts and sharp points may be present prior to assembly.

**Care Instructions**  
To clean your product, use mild soap and water on a damp cloth. Do not use window cleaners or cleaning abrasives as they will scratch the surface and could damage the protective coating.

**Customer Service**  
For questions regarding this product, or to receive replacement or missing parts, contact Customer Service at (800) 524-3555. Please have the model number and part number(s) located in this Assembly Instruction sheet available for reference.

**Limited Warranty**  
All Guidecraft products are warranted to the original purchaser at the time of purchase and for a period of one (1) year thereafter. In order to provide you with timely assistance, please thoroughly inspect your product for missing or defective parts immediately after opening the carton. To receive replacement or missing parts under this warranty, contact Customer Service. You will also need your sales receipt or other proof of purchase.

**Hardware and Parts**

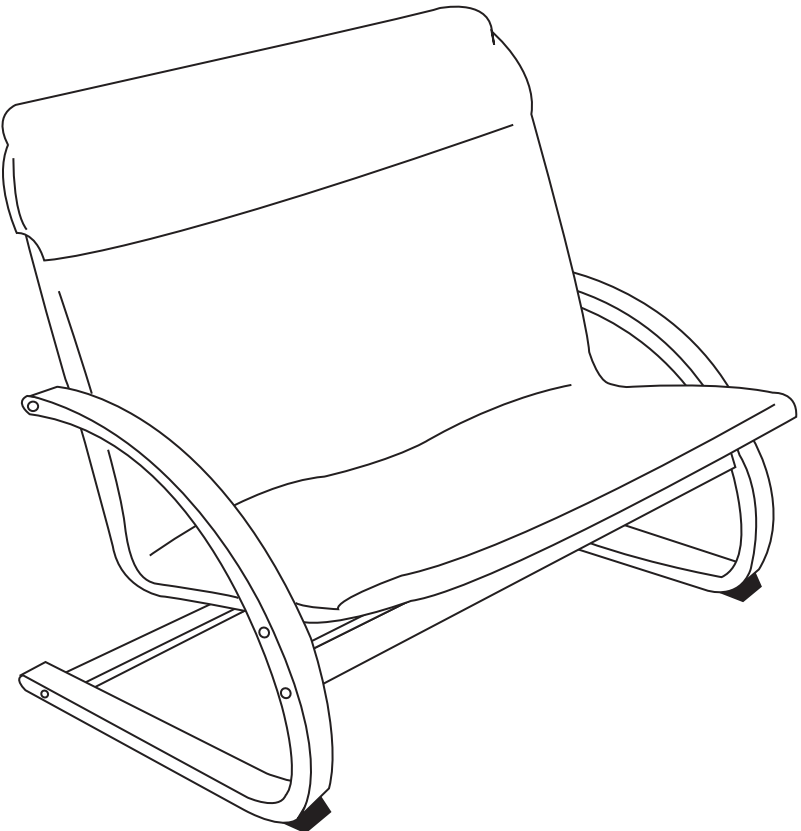
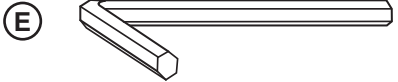
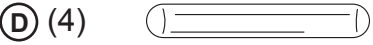
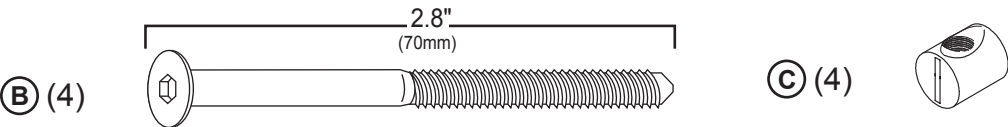
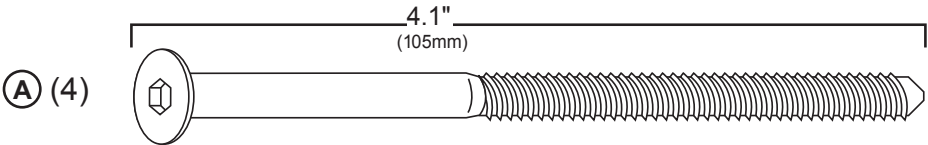

STEP 1

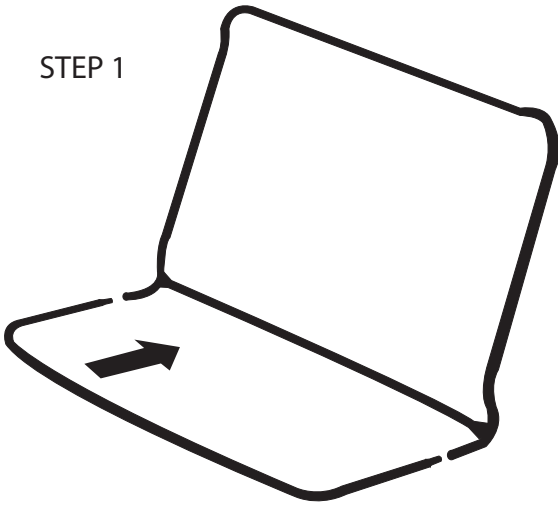

STEP 2

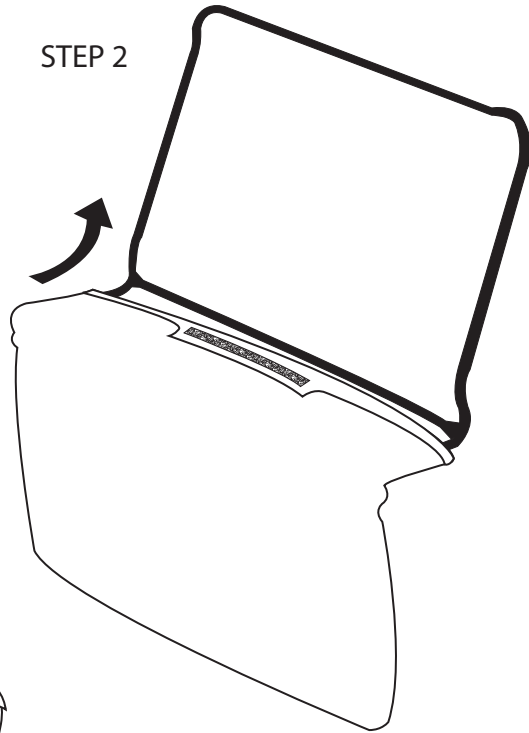

STEP 3

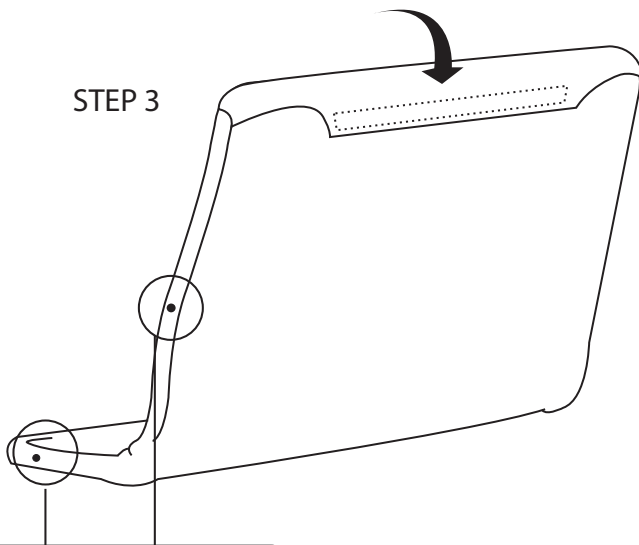

Ensure the holes in the fabric cover line up with the holes in the metal frame after the cover is attached. If the holes do not line up, you may have installed the cover upside down.

**BURN HOLES IN COVER**

Please note: The holes in the cover are burned at the edges to prevent fraying. They are not a product flaw.

STEP 4

