

# Central Brass®

The Easy Choice

## KITCHEN TOPMOUNT FAUCET

6 Inch Centers  
Cast Brass Body  
Hose & Spray

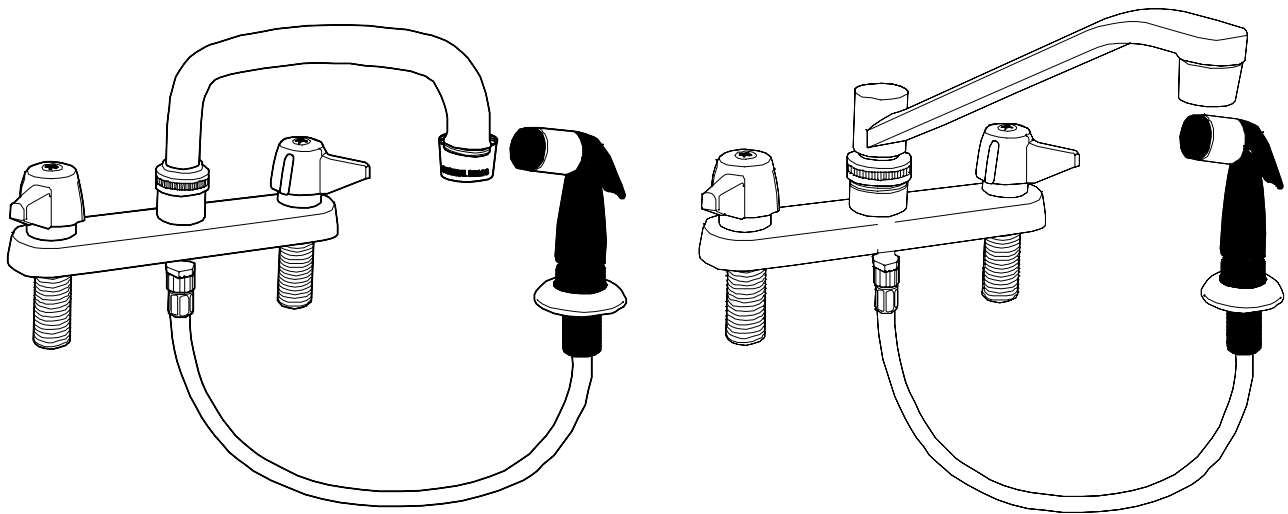

6" Centers with Hose & Spray and Compression Stem Assemblies

**0126 - A Series with 8-inch Swivel Spout**

**0128 - A Series with 8-inch D-Spout**



Faucets with lever, wrist or elbow handles and compression or ceramic stem cartridges are ADA compliant.



Certified to  
ANSI/NSF 61 Section9

**CENTRAL BRASS MFG CO**

2950 East 55th Street, Cleveland, Ohio 44127

Phone: 216-883-0220 Fax: 216-883-0875 Email: sales @CentralBrass.com

# CENTRAL BRASS INSTALLATION INSTRUCTIONS

**NOTE:**  
Faucets supplied without hose and spray should be flushed with only the aerator removed.

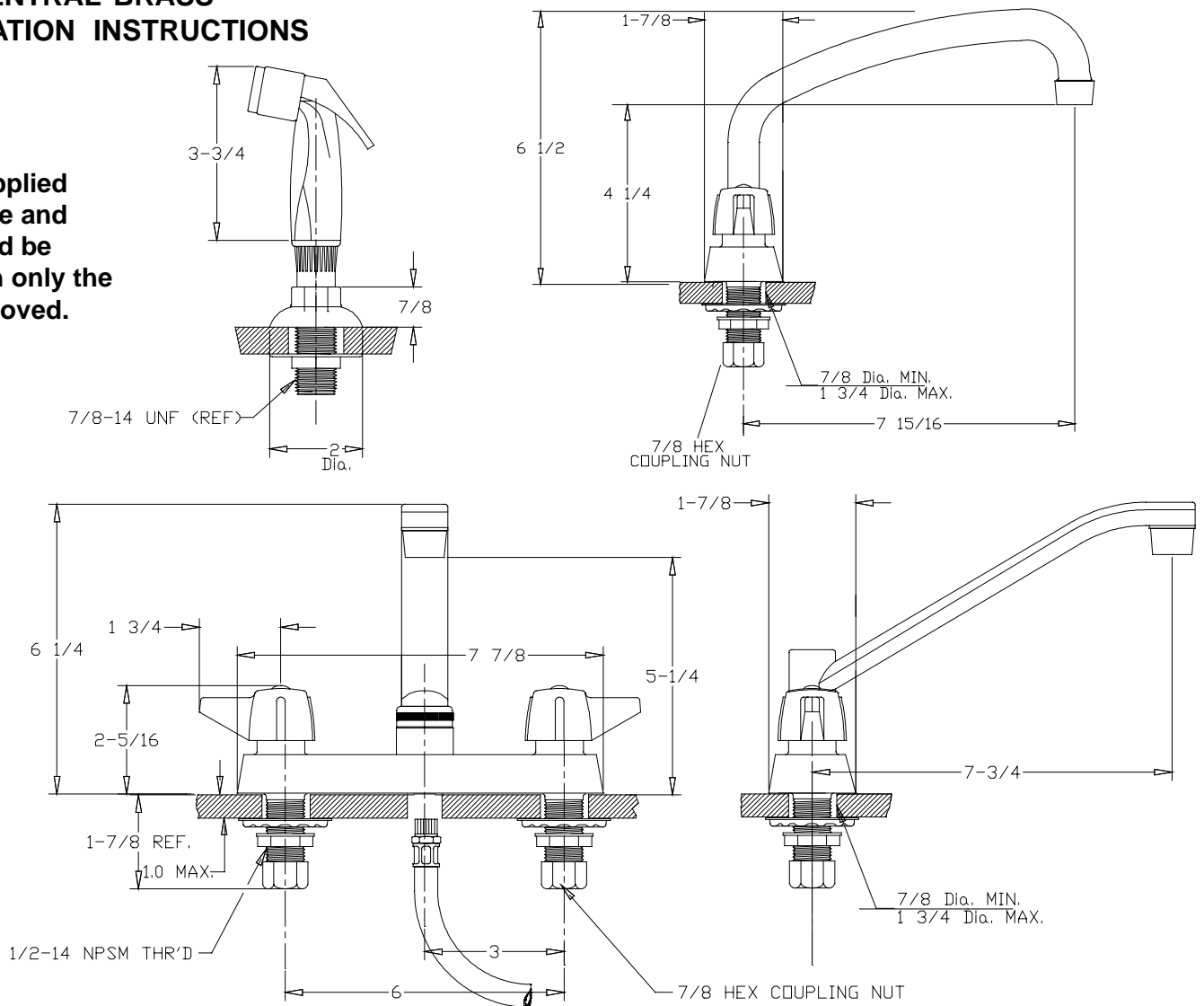

1. Remove locknut from hose guide and place through proper hole in sink. Re-assemble locknut on shank and tighten.
2. Insert hose end of spray hose assembly down through hose guide then up through center faucet hole in sink. Attach to threads of nipple from the bottom center of the fixture body. **Tighten by hand to finger tight + 1/4 turn max.** If need be, diverter assembly can be held through spout hole with a 3/8 hex wrench while tightening hose. Ensure that diverter assembly does not back out and break O-Ring seal.
3. Apply a thin coat of soft plumbers putty to the bottom edge of the faucet body, place the faucet shanks thru the holes in the sink. (Handles indexed cold on right side, body marked on bottom front for those without handle indexes).
4. Attach steel washer and locknuts and tighten. Connect hot water supply to left side and cold water supply to right side. Tighten coupling nuts securely.
5. Remove aerator (if needed) from spout and install on to body. Turn on hot and cold water for one minute to flush out dirt and sediment that might have accumulated in lines during installation. Assemble aerator to spout.
7. Test spray rinse for proper operation and check all connections for leakage.

**CENTRAL BRASS MFG CO**

2950 East 55th Street, Cleveland, Ohio 44127

Phone: 216-883-0220 Fax: 216-883-0875 Email: sales @CentralBrass.com

# REPLACEMENT PARTS

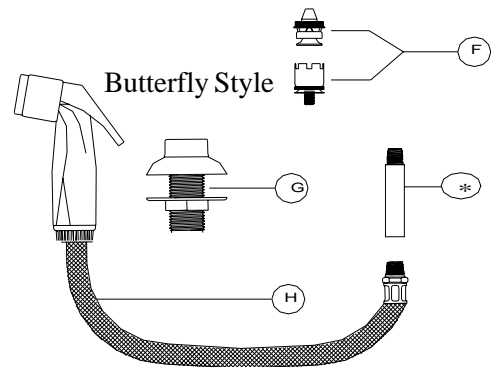
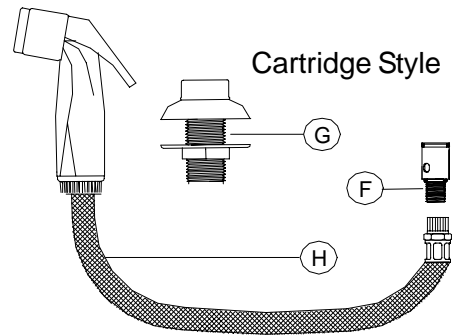
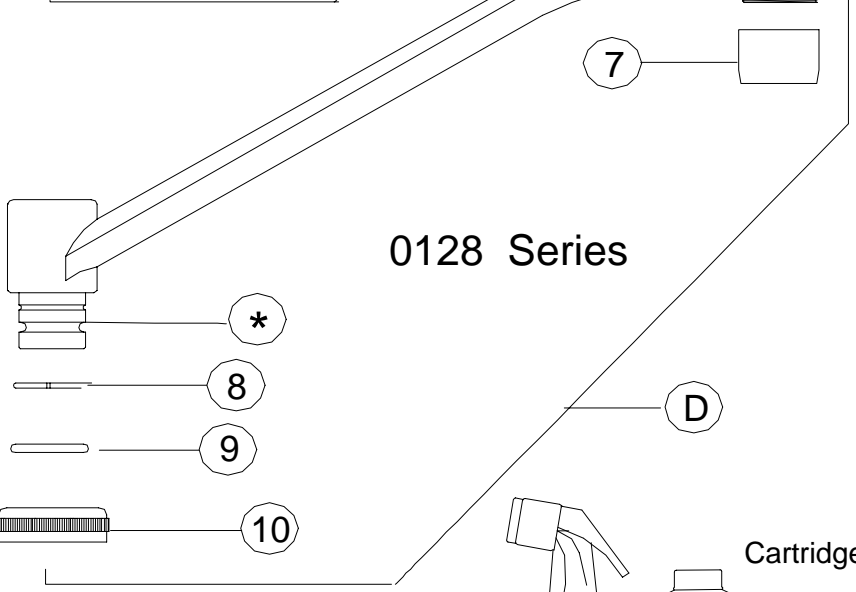
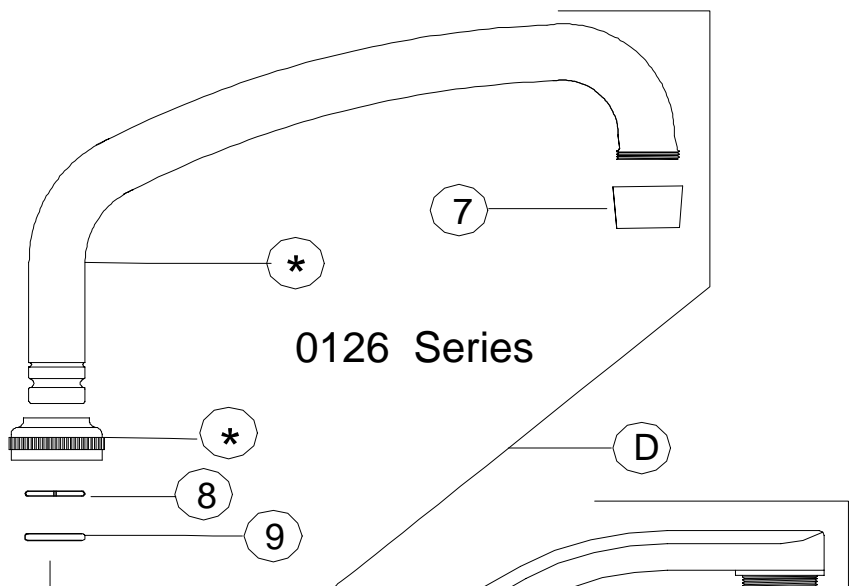
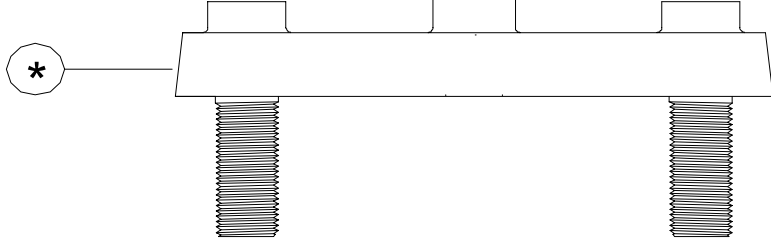
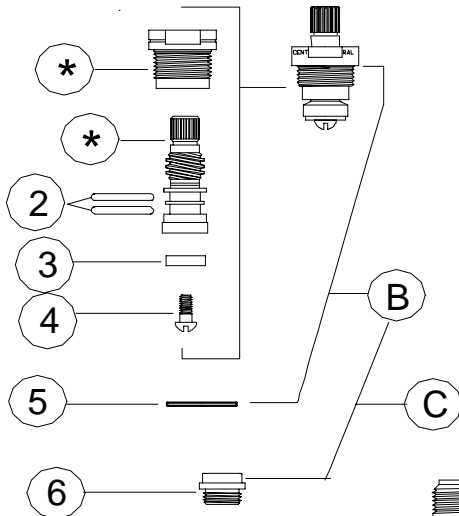
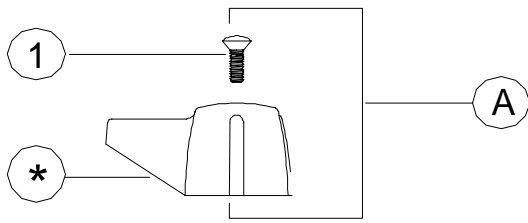

\* These items are not offered individually and must be purchased as a group or unit. Please contact Central Brass for more information.



**CENTRAL BRASS MFG CO**

2950 East 55th Street, Cleveland, Ohio 44127

Phone: 216-883-0220

Fax: 216-883-0875

Email: sales @CentralBrass.com

# REPLACEMENT PARTS

#	Part #	Description
A	G-523-C	Lever Handle C Indexed with Screw (X107-F)
A	G-523-H	Lever Handle H Indexed with Screw (X107-F)
B	G-453-EL	Cold O-Ring Stem Assembly with Gasket (X1028-Y)
B	G-453-ER	Hot O-Ring Stem Assembly with Gasket (X1028-Y)
C	K-453-C	Cold O-Ring Stem Assembly with Gasket (X1028-Y) and Seat (X263-BC)
C	K-453-H	Hot O-Ring Stem Assembly with Gasket (X1028-Y) and Seat (X263-BC)
D	SU-363-RA	8-Inch Swivel Spout with Aerator (30-M) 0126 Series
D	SU-365-CA	8-Inch Swivel D-Spout with Aerator (30-M) 0128 Series
E	G-913-A	Coupling Nut group (1 set)
F	SU-266	Diverter Cartridge (for cartridge style)
F	166-DE	Upper & Lower Diverter unit (for butterfly style)
G	SU-2987-DA	Guide for Hose & Spray
H	266-A	Hose & Spray assembly (female connector for cartridge style)
H	166-A	Hose & Spray assembly (male connector for butterfly style)
1	X107-F	Handle Screw (25 pcs per pack)
2	X1038-453	O-Rings (25 pcs per pack)
3	X901-WNN	Stem Seat Washer (25 pcs per pack)
4	X104	Seat Washer Screw (25 pcs per pack)
5	X1028-Y	Gasket (25 pcs per pack)
6	X263-BC	Replacement Seat (10 pcs per pack)
7	30-M	Aerator
8	X166-FN	Snap Ring (6 pcs per pack)
9	X1038-KN	Spout O-Ring (25 pcs per pack)
10	X54	Crowfoot Washer (10 pcs per pack)
11	X7133-AL	Locknut (10 pcs per pack)
12	X4015	Coupling Nut (4 pcs per pack)

## OPTIONS & REPLACEMENT PARTS for options

Suffix Number	Replaces Item #	Part Number	Description
2	D	SU-363-JA	10-Inch Swivel Spout with Aerator (30-M)
3	D	SU-363-LA	12-Inch Swivel Spout with Aerator (30-M)
4	D	SU-363-MA	14-Inch Swivel Spout with Aerator (30-M)
8	D	SU-357-HSA	7 ¼ Inch High-Rise Swivel Spout with Aerator (30-L)
70	A	K-506-1C or 1H	Acrylic Handle with C or H metal indexed button
		X126-625B	Handle Screw for Acrylic Handles suffix's 70 or 80 (6 pcs per pack)
		G-503-M-02	Metal indexed buttons C & H for Acrylic Handles suffix's 70 or 80 (one pair per pack)



- If faucet has round handles (70 or 80 suffixes) , use two Hot stem assemblies
- If faucet has lever handles, use one Hot and one Cold stem assemblies

## CENTRAL BRASS MFG CO

2950 East 55th Street, Cleveland, Ohio 44127

Phone: 216-883-0220 Fax: 216-883-0875 Email: sales @CentralBrass.com

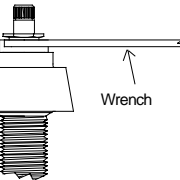
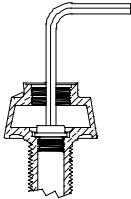
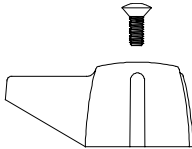
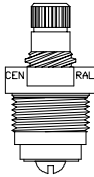
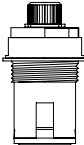
# CENTRAL BRASS MAINTENANCE INSTRUCTIONS

DISASSEMBLY	REPLACEMENT
<div style="border: 1px solid black; padding: 5px; margin-bottom: 5px;"> <p><b>1 REMOVE HANDLE</b></p>  <p>1. Turn off water supply. 2. Remove screw. 3. Remove handle.</p> </div> <div style="border: 1px solid black; padding: 5px; margin-bottom: 5px;"> <p><b>2 REMOVE STEM ASSEMBLY</b></p>  <p>1. Use adjustable wrench. 2. Unscrew (counter-clockwise) remove stem unit.</p> </div> <div style="border: 1px solid black; padding: 5px;"> <p><b>3 REMOVE SEAT</b> (For compression stems only)</p>  <p>1. Insert 5/16" allen wrench in seat. 2. Turn seat (counter-clockwise) to remove.</p> </div>	<div style="border: 1px solid black; padding: 5px; margin-bottom: 10px;"> <p><b>4 Use Only Genuine Central Replacement Parts</b></p> <p><b>Compression Units</b>  <b>G-453-ER</b> Hot stem assembly  <b>G-453-EL</b> Cold stem assembly  <b>X263-BC</b> Replaceable Seat</p> <p><b>Ceramic Units</b>  <b>K-352-H</b> Ceramic Hot stem assembly  <b>K-352-C</b> Ceramic Cold stem assembly</p> </div> <div style="text-align: center;">            <p style="text-align: center;"><b>COMPRESSION</b>                      <b>CERAMIC</b></p> </div>

- If faucet has round handles (70 or 80 suffixes) , use two Hot stem assemblies
- If faucet has lever handles, use one Hot and one Cold stem assemblies

**CENTRAL BRASS MFG CO**  
 2950 East 55th Street, Cleveland, Ohio 44127  
 Phone: 216-883-0220    Fax: 216-883-0875    Email: sales @CentralBrass.com