

PK.SENTR

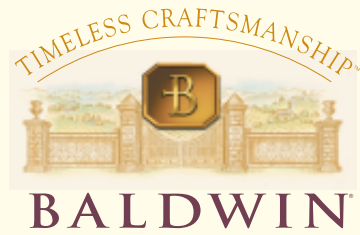

*Installation Instructions*  
ENGLISH

*Premium Entrance Set*  
SINGLE CYLINDER  
SECTIONAL TRIMS

Canterbury®



5305

Logan™



5315

Madison®



5320



**Remember Baldwin**

With the completion of your project, remember that Baldwin quality hardware and giftware products are available for all your decorating and remodeling needs. Matching entrance sets for exterior doors, beautiful bath accessories, and a complete selection of cabinet and door-enhancing hardware are all available from your Baldwin retailer.

To request a product brochure or the name of a retailer near you, call 1-800-566-1986.

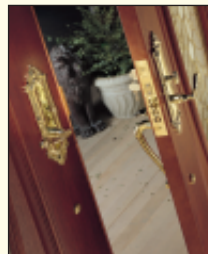

Baldwin offers a vast array of exceptional solid brass products to elegantly enhance all areas of the home. Each collection features a wide variety of beautiful, high-fashion finishes. From locking products to lighting and bath accessories, Baldwin provides the discriminating decorator with numerous options to accent and complement the home's ambience with distinction, taste, and fine detail.

PK.SENTR  
08/20/02

**Congratulations!**

With your purchase of this Premium Entrance Set, you're among a group of discerning individuals who know the intrinsic value of selecting the finest—Baldwin.

Our step-by-step installation instructions will help guide you through your project quickly and easily.

Before you begin your installation, read and understand the installation instructions and marking templates. If you have any questions, please do not hesitate to contact our Baldwin Consumer Help Line at 1-800-566-1986. We're here to help! We thank you for your purchase and wish you the fullest enjoyment of your Baldwin product.

**Care and Maintenance**

**WARNING:** Do not attempt to clean your hardware with any type of abrasive cleaners, solvents, or chemicals. These types of cleaning agents may mar the finish. A damp cloth is all that is necessary to wipe clean.  
Note: Finish Number 102, Oil-Rubbed Bronze, can be cleaned with light machine oil and wiped with a dry cloth.



**Complimentary Baldwin Security Test and Rebate Offer**

Be assured that your home is safe and secure with Baldwin's Security Test. To get yours free, download it at [www.baldwinhardware.com/security](http://www.baldwinhardware.com/security) and receive a special online rebate offer. Or write to Baldwin Hardware Corporation, P.O. Box 15048, Reading, PA 19612.



**Consumer Help Line**  
**1-800-566-1986**

Hours: 6 a.m. to Midnight C.S.T.—7 days a week  
If you have trouble installing your Baldwin product, feel free to call our toll-free Consumer Help Line.

[www.baldwinhardware.com](http://www.baldwinhardware.com)



© Baldwin Hardware Corporation - A Masco Company  
P.O. Box 15048, Reading, PA 19612



[www.baldwinstyleguide.com](http://www.baldwinstyleguide.com)

## Required Tools



Protective Eyewear



Phillips Screwdriver



Flat Head Screwdriver

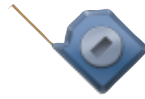

Tape Measure



Electric Drill



2 1/8" Dia. Face Bore Hole Saw



1/2" Wood Chisel



1/8" Wood Drill Bit



5/16" Wood Drill Bit



1" Spade Bit or 1" Hole Saw (Recommended)



Chalk, Grease Pencil, or Lipstick



Pencil

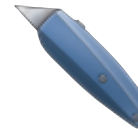

Utility Knife



Masking Tape



24" Level



Hammer



5/32" Wood Drill Bit

## Helpful Tools



Wood Filler



Beeswax or Soap

# 1 Before You Begin

- Remove and discard all materials and screw(s) used for packing your Premium Entrance Set. Verify that you have all parts pictured on exploded view section of instructions.
- Check the thickness of the door. This lockset works on doors 1 3/4" thick only. For doors greater than 1 3/4" up to 2 1/4" thick, contact our Consumer Help Line at 1-800-566-1986. The conversion kit part number for this item is 5399.XXX.A; please specify the finish of your product.
- **Follow the step-by-step sequence to ensure proper operation of your Baldwin lockset.**
- If your door is pre-drilled, see handleset installation step 1. If it is not pre-drilled, see door preparation step 1.
- **Important!** If you are removing an old lock and replacing it with this Baldwin lockset, you must install the Baldwin strikeplate provided. Failure to do so could void your warranty. You may need to plug existing holes left by the old strikeplate screws with wood dowels and re-drill the pilot holes for the new strikeplate.
- We recommend spreading cardboard over floor to prevent scratching parts and marring floor.
- Always wear protective eyewear.

**Note:** The illustrations in these instructions depict the outside handle being installed on the right of the door. For installation of the outside handle on the left of the door, proceed as if all illustrations were reversed.

## Exploded View

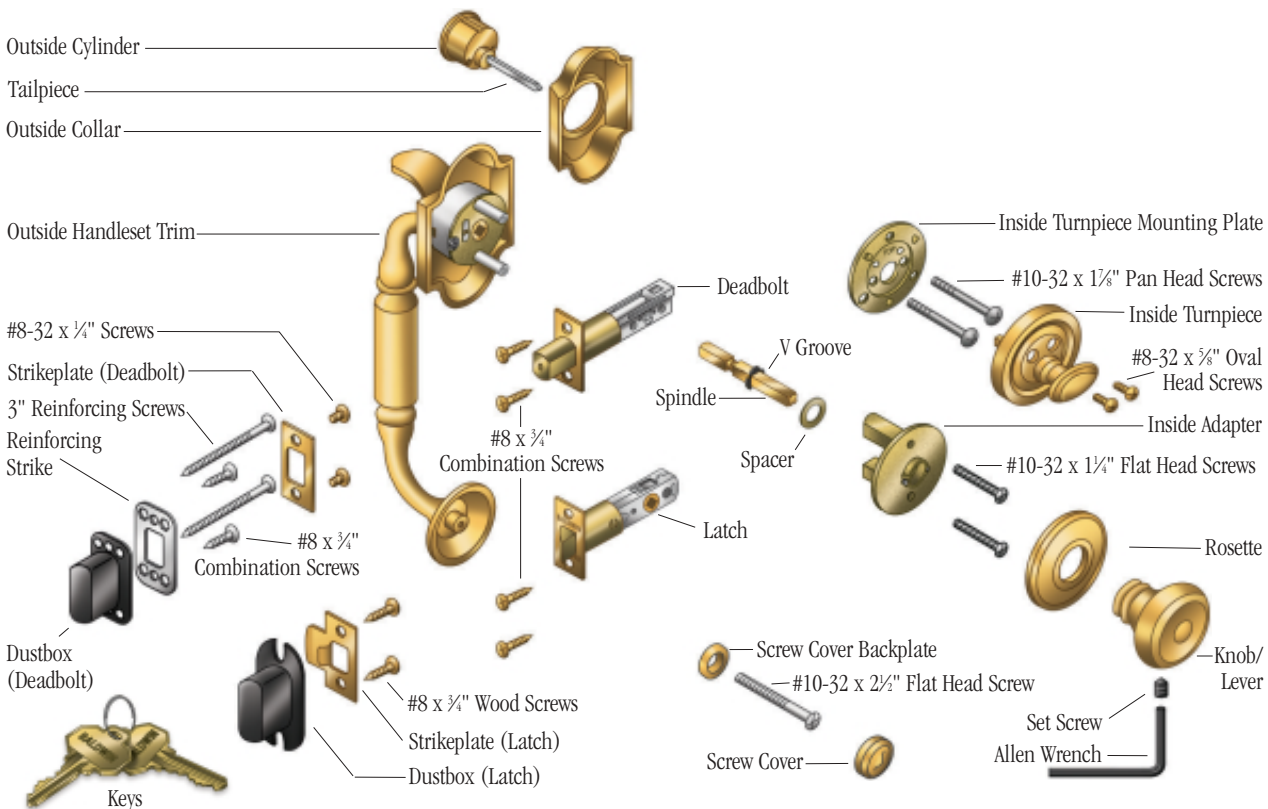

## Handleset Installation Fasteners

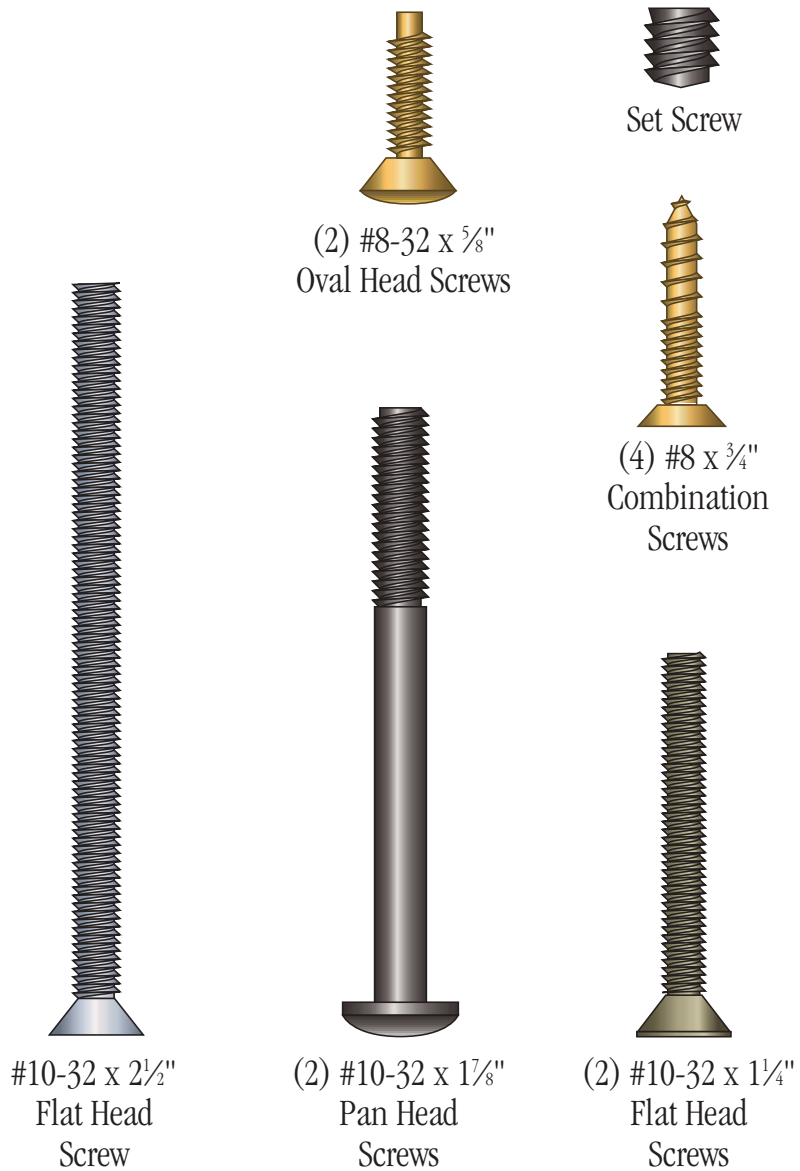

## Strikeplate Installation Fasteners

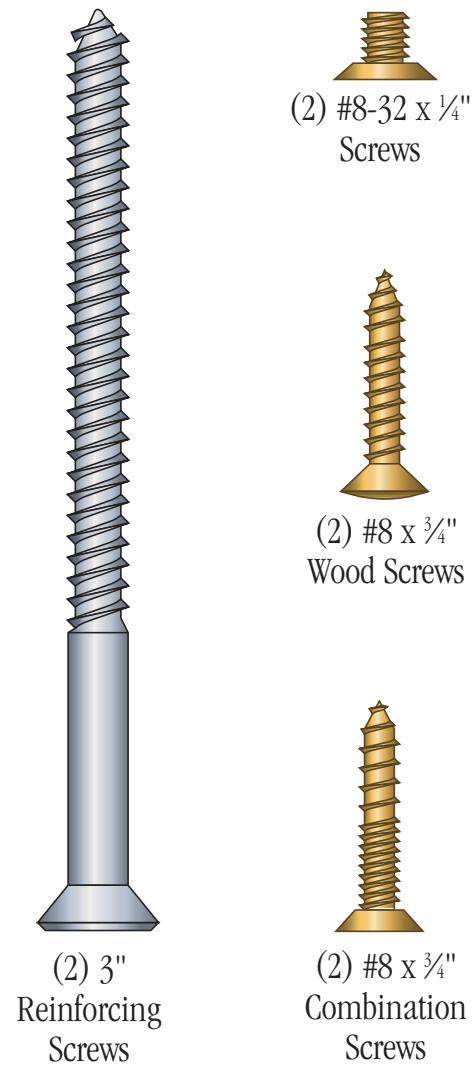

# Door Hole Template

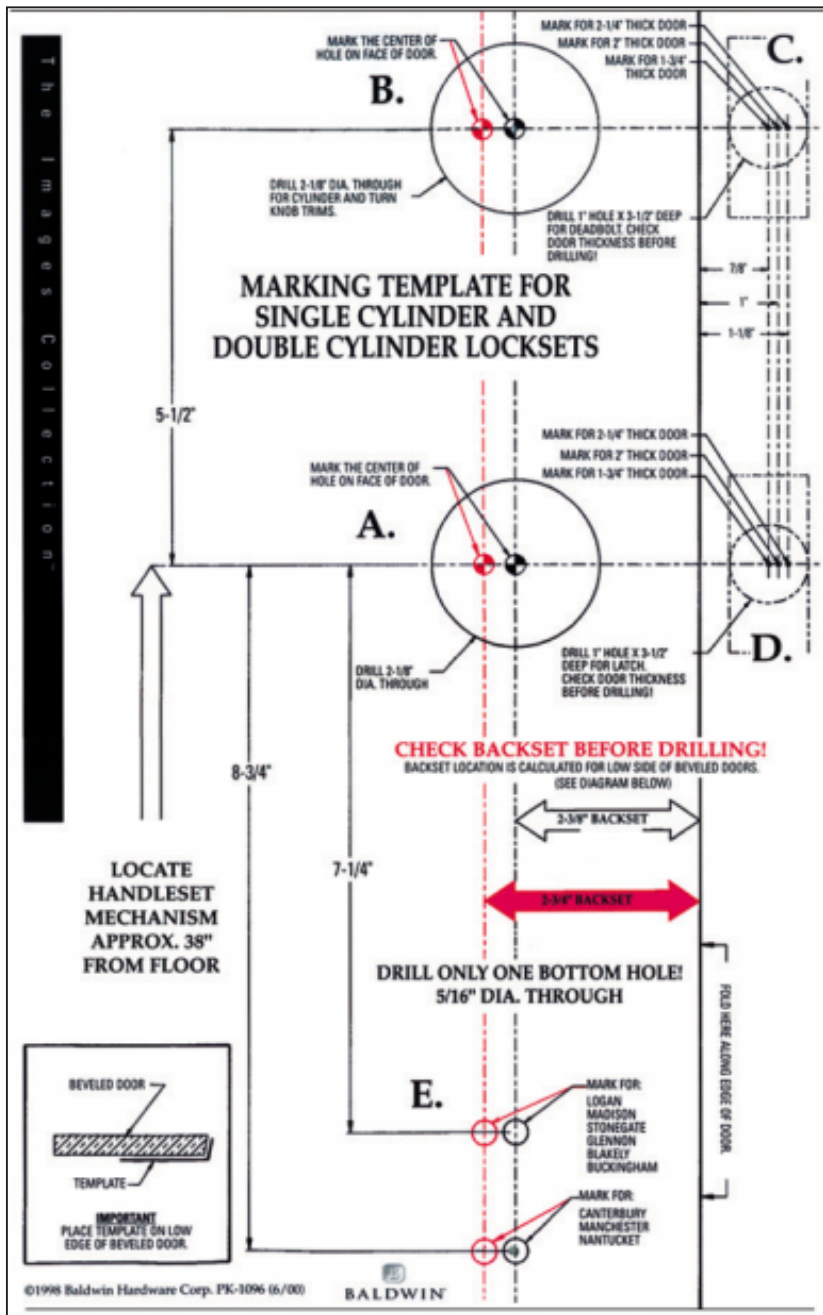

# Door Frame Template

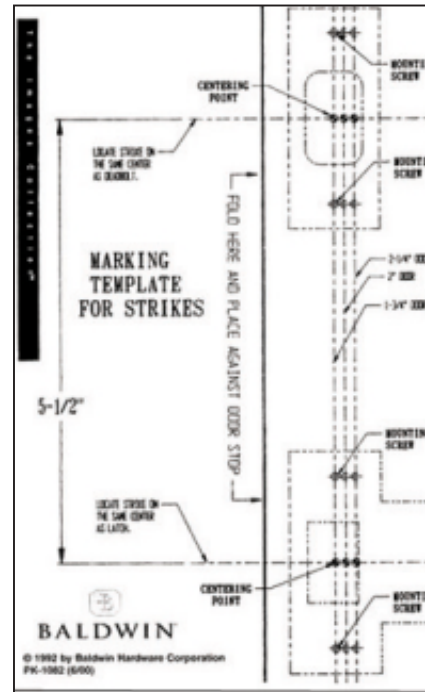

## 2 Door Preparation (If Needed)



**1** Pull door toward you to check if it's level. Observe contact of door to jam and make sure it's level. Adjust if necessary.

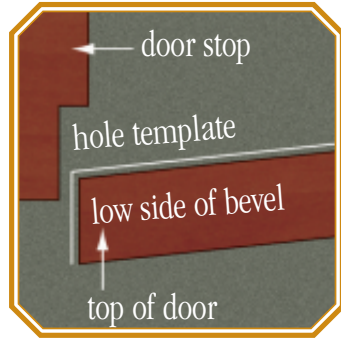

**2** (Aerial View) To ensure proper alignment, only use hole template on side facing doorstop.  
**Helpful Hint:** Some doors have a beveled edge with bevel facing doorstop.

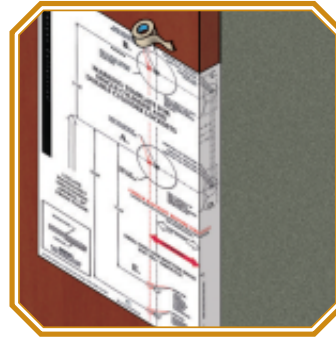

**3** Fold hole template along door edge with center of bottom hole (A), the  $2\frac{1}{8}$ " dia. hole, 38" from floor. Tape template to door.

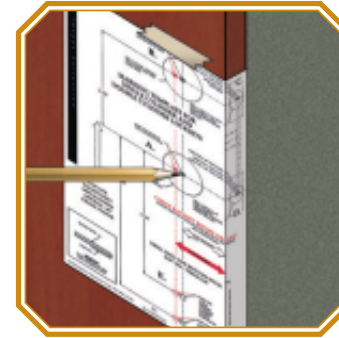

**4** Determine backset, which is the distance from the edge of door to center of hole. Use hole template to mark the backset center point for your installation. Locate and mark positions for (A, B, C, D, and E) on template. The most common backset is  $2\frac{3}{8}$ ".

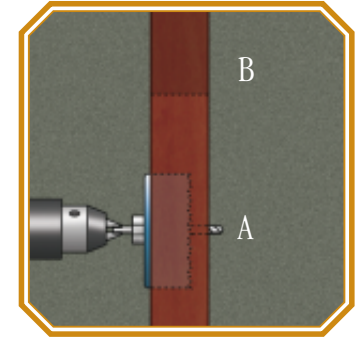

**5** Very carefully drill (A, B)  $2\frac{1}{8}$ " holes into one side of door face until drill bit starts to protrude on opposite side.  
**Important:** Drill perpendicularly (at a 90° angle) to door.

## 2 Door Preparation (If Needed) cont.

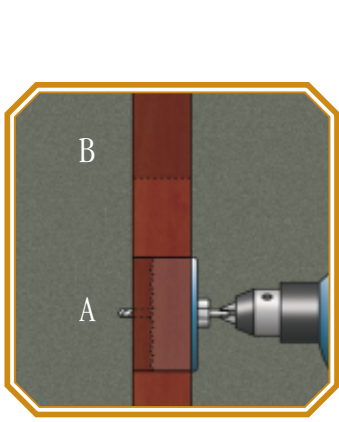

**6** Complete drilling holes (A, B) from opposite side of door.

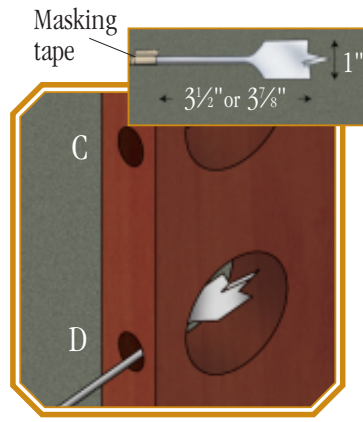

**7** Very carefully drill (C, D) holes into door edge exactly at pencil marks.  
 $3\frac{1}{2}$ " deep for a  $2\frac{3}{8}$ " backset  
 $3\frac{7}{8}$ " deep for a  $2\frac{3}{4}$ " backset  
**Helpful Hint:** Mark edge depth of drilling with masking tape.

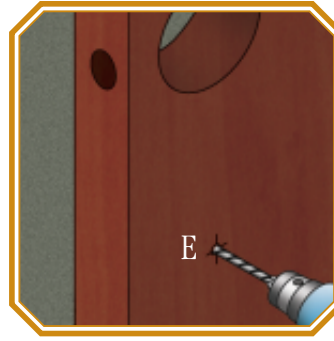

**8** Very carefully drill (E)  $\frac{5}{16}$ " hole into door exactly at pencil mark.

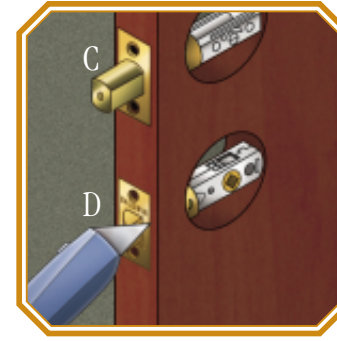

**9** Insert latch into hole (D). Use utility knife to score chisel guides into door edge. Make sure score guides are parallel to door. Repeat for deadbolt hole (C).



**10** Chisel faceplate cavity  $\frac{5}{32}$ " deep.  
**Helpful Hint:** Chisel toward inside edge of score lines, removing only a small bit to avoid wood damage.

### 3 Handleset Installation



**1** Determine your backset, which is the distance from the edge of door to center of hole. Your lockset is shipped with a  $2\frac{3}{8}$ " backset (most common). Adjust for a  $2\frac{3}{4}$ " backset door only.

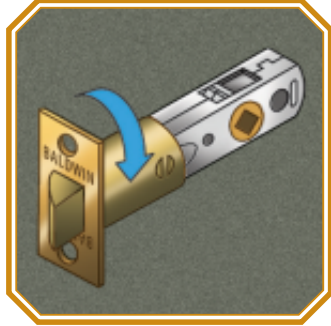

**2** For a  $2\frac{3}{4}$ " backset, grasp body and twist faceplate  $180^\circ$  until it stops. Angled side of bolt should face outside. Follow same procedure for deadbolt.  
**Note:** See deadbolt orientation during installation step 4.

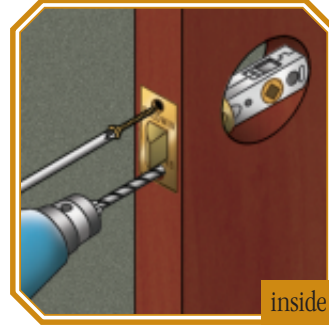

**3** Insert latch with angled side of bolt facing outside. Drill  $\frac{1}{8}$ " pilot holes. Secure with  $\#8 \times \frac{3}{4}$ " combination screws so latch is flush with door. Repeat for deadbolt.  
**Helpful Hint:** When installing wood screws it is recommended to put beeswax or soap on screw threads to improve installation.

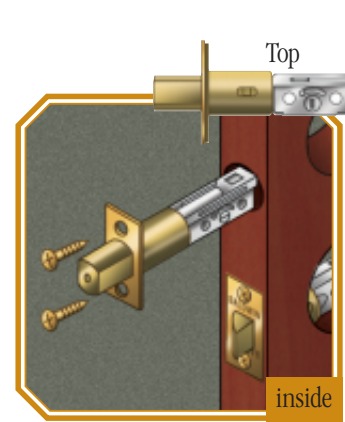

**4** Note orientation of deadbolt. Insert deadbolt. Drill  $\frac{1}{8}$ " pilot holes. Secure with  $\#8 \times \frac{3}{4}$ " combination screws so latch is flush with door.

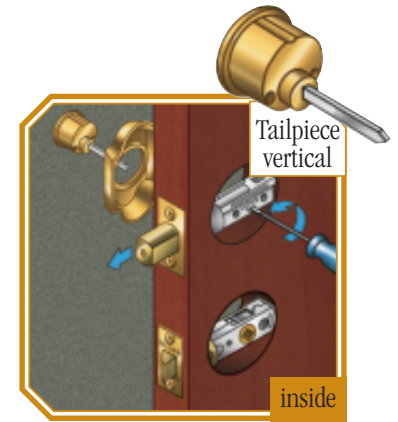

**5** **Extend deadbolt with flat head screwdriver.** Keeping tailpiece vertical, insert cylinder through collar and into deadbolt. Hold in place. Do not insert key.



### 3 Handleset Installation (cont.)

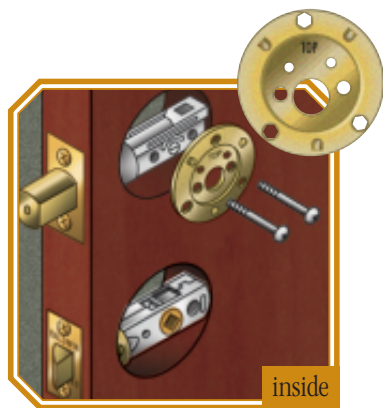

**6** Place turnpiece mounting plate on inside of door. Attach to cylinder using two #10-32 x 1/8" pan head screws. Tighten screws.  
**Important:** Note orientation of mounting plate.



**7** Place inside turnpiece over mounting plate. Insert tail-piece into inside turnpiece. Attach inside turnpiece to mounting plate with two #8-32 x 5/8" oval head screws. Make certain turn knob rotates smoothly in both directions.



**8** Attach handle by inserting the #10-32 x 2 1/2" flat head screw on inside of door through screw cover backplate and the lower hole (E). Leave screw loose for adjustment.  
**Note:** Go to door preparation if you do not have a lower hole (E).

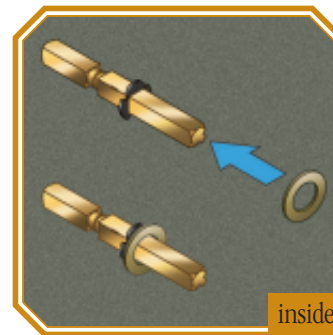

**9** Measure the thickness of your door. If door is less than 1 3/4" thick, do not use the spacer provided. If your door measures 1 3/4", slide the spacer onto spindle.

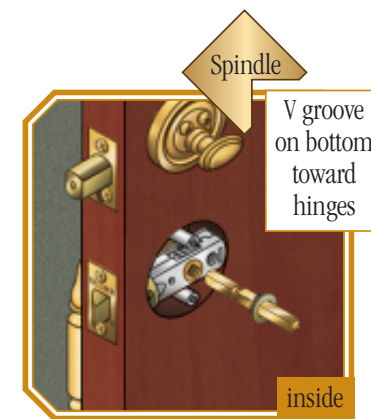

**10** From inside of door, insert short end of spindle through the latch with the V groove on the bottom angled down and toward hinges. Position outside handle set trim so spindle slides into square hole in thumbpiece cartridge.  
**Note:** Make certain spindle is inserted through the latch to stops.

### 3 Handleset Installation (cont.)



**11** Align spindle, latch, and outside handle. Insert the inside adapter onto the posts of the outside handle. Secure with two #10-32 x 1/4" flat head screws. Tighten all three screws, including screw for bottom of handle.

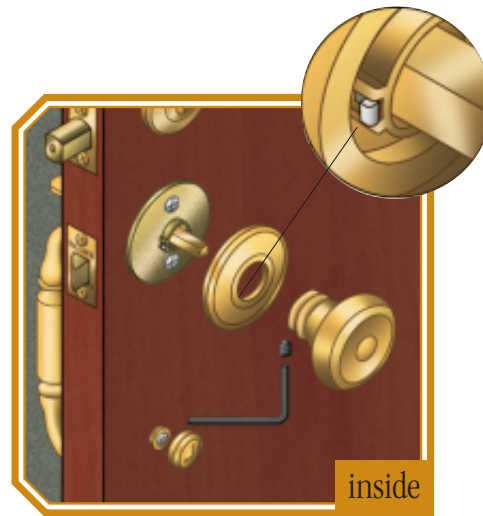

**12** Position rosette onto adapter with third slot (smaller) facing down; snap into place. Slide knob onto spindle and tighten set screw with Allen wrench. Knob/lever is secured when set screw enters V groove in spindle. Attach bottom screw cover.

#### Removing Rosette

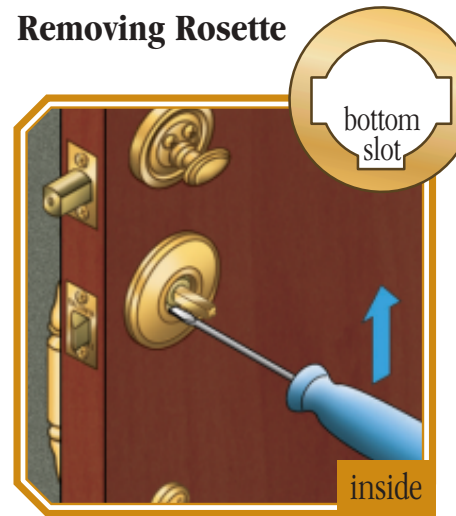

If you need to remove rosette after installation, loosen set screw and remove knob/lever. Place flat head screwdriver into bottom slot of rosette and pry off.

#### Lever Version



The lever version of this product comes with both left-hand and right-hand levers. You will only use one in the installation. To determine which lever to use, make sure that the handle portion of the lever extends toward the hinges of the door and the hole for the set screw faces down.

## 4 Strikeplate Installation

**IMPORTANT!** You must install Baldwin strikeplate or your warranty is void.



**1** If weather stripping is not installed, you must install weather stripping prior to strikeplate installation. Mark center of deadbolt with chalk, grease pencil, or lipstick. Shut door and lock deadbolt to mark center point on doorframe.



**2** On doorframe, align strike hole template with center point. Mark holes for center of latch bolt and outer corners of both strikes with pencil.



**3** For Deadbolt and Latch Strikeplates: Mark drill points  $\frac{5}{16}$ " above and below center points. Bore two 1" holes  $\frac{1}{4}$ " deep for deadbolt dustbox and two 1" holes 1" deep for latch dustbox. Score chisel guide into doorframe with utility knife.



**4** For Deadbolt and Latch Strikeplates: Chisel out holes for dustboxes. Chisel out cavity so deadbolt strikeplate and latch strikeplate fit flush with doorframe. For deadbolt strikeplate, cavity is  $\frac{7}{32}$ " deep. For latch strikeplate, cavity is  $\frac{3}{32}$ " deep.

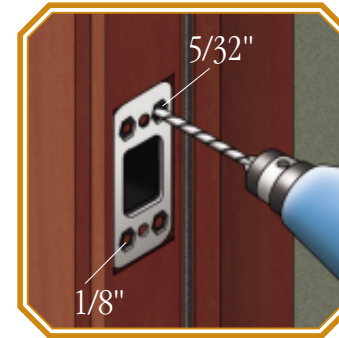

**5** For Deadbolt Strikeplate: Using reinforcing strikeplate as a template, drill two  $\frac{5}{32}$ " pilot holes for 3" long screws (outside holes) and two  $\frac{1}{8}$ " pilot holes for #8 x  $\frac{3}{4}$ " screws (inside holes).

## 4 Strikeplate Installation (cont.)

**IMPORTANT!** You must install Baldwin strikeplate or your warranty is void.

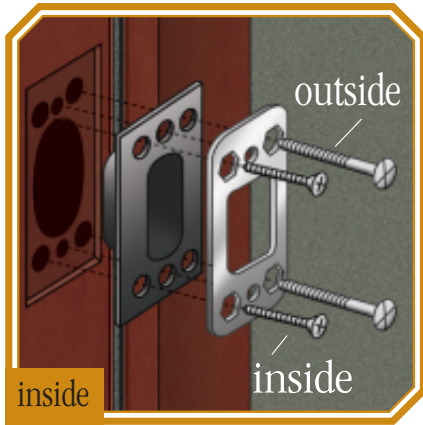

### 6 For Deadbolt

**Strikeplate:** Insert dustbox into hole, add reinforcing strike, and secure with 3" reinforcing screws (outside holes) and #8 x 3/4" combination screws (inside holes).

**Helpful Hint:** When installing wood screws it is recommended to put beeswax or soap on screw threads to improve installation.

### 7 For Deadbolt

**Strikeplate:** Add strikeplate and secure with #8-32 x 1/4" screws.

### 8 For Latch Strikeplate:

Using latch strikeplate as a template, drill two 1/8" pilot holes for the #8 x 3/4" screws.

### 9 For Latch Strikeplate:

Insert dustbox into hole, add strikeplate, and secure by inserting #8 x 3/4" wood screws into pilot holes.

# Troubleshooting Guide

If parts are missing do not return product. Please call Baldwin's Consumer Help Line at 1-800-566-1986 and we will quickly send the parts to you.

## Problem

Can't extend deadbolt unless key is in cylinder. Can't remove key with deadbolt in extended position.

## Solution

Cylinder is out of time. Remove turn knob assembly and cylinder. Extend deadbolt with screwdriver and re-install hardware. Refer to handleset installation step 5.

Screws are all tight but the hardware is not firmly attached to the door.

Check door thickness. Door must be 1 $\frac{3}{4}$ " thick. Hardware will not install on doors less than 1 $\frac{3}{4}$ " thick.

Inside knob or lever spins freely and does not retract latch bolt. Deadbolt retracts when thumbpiece on outside is pushed.

Spindle is installed backwards. Short side of spindle must face exterior of house. Long side of the spindle is installed toward inside of house. Refer to handleset installation step 10.

Knob or lever keeps coming off the spindle.

Ensure that set screw on knob or lever is installed in V groove on spindle and securely tightened with Allen wrench provided. Refer to handleset installation step 12.

Door is difficult to latch or will not stay closed unless deadbolt is extended.

Strikeplate is not aligning with latchbolt. Remove, plug holes with wooden dowels and glue. Adjust and re-install. Condition can also be caused by weather stripping being installed after hardware is installed. Re-install strike as described at left. Refer to strikeplate installation step 1.

Can't extend deadbolt from inside with turn knob or outside with key when door is closed.

Open door and try to extend deadbolt. If deadbolt extends easily with door open, deadbolt strike is not aligned with deadbolt. Remove strike and relocate as necessary. Refer to strikeplate installation step 1.

Door is already prepared with round hole for latch.

Replace door or return lockset to place of purchase. Baldwin does not manufacture a round (drive-in) latch at this time.

Deadbolt will only retract fully when retracted forcefully and quickly. Will not retract fully when retracted slowly.

Wrong deadbolt may have been supplied. Call our Consumer Help Line at 1-800-566-1986 for assistance.

Deadbolt works easily with turn knob on inside but is difficult to turn and has grinding sound when turned with key on outside.

Improper alignment of cylinder and turnpiece or improper door thickness. Use a block of wood to tap cylinder collar so it will not move more than  $\frac{1}{16}$ " in any direction. If this does not correct problem, check deadbolt hole preparation for accuracy. Ensure that door is 1 $\frac{3}{4}$ " thick. Refer to handleset installation step 5.