

JULIEN

Donnez vie à vos idées.
Make your ideas real.

SPECIFICATIONS

Category: **Kitchen sink**

MODEL: **3253**

Type: **Undermount Double Bowl**

Collection: **Classic™**

FEATURES:

- Handcrafted in Canada using recycled American stainless steel
- Commercial grade - 16 ga material thickness
- Corrosion resistant 304 series stainless steel (18/10)
- Elegant no. 4 brushed finish (appliance finish)
- Highly efficient sound deadening pads
- Practical flat sink bottom and straight bowl sides
- Stylish and functional bowl bottom grooves
- Optional in-bowl storage drawer
- Rear 3-1/2" drain placement
- Limited lifetime warranty

STANDARDS COMPLIANCE:

- ASME A112.19.3
- CSA B45.0-02
- CSA B45.4-02

OPTIONAL ACCESSORIES:

- Grid LG #200150 SM #200149
- Colander #205008
- Cutting board #210036

WARRANTY:

Julien inc. offers a LIMITED LIFETIME WARRANTY on the [fix] components of its stainless steel sinks against defects of material and workmanship. For further details on our product warranty, please refer to our catalog or Web site.

PRODUCT SPECIFICATIONS:

Sink type to be undermount double bowl. Sink to be handcrafted from a single sheet of 16 ga stainless steel having 18/10 chrome/nickel content and a no.4 brushed finish. Sink to feature bowl bottom grooves, rear Ø3 1/2" drain placement and sound insulation pads. Sink overall dimensions to be 35" left-to-right and 17,5" front to back. LH bowl dimensions to be 18" left-to-right and 16" front to back. RH bowl dimensions to be 15" left-to-right and 16" front to back. Sink to feature 29mm radius corners. Sink to be Julien Classic™ collection model no. 3253 with bowl depth of 10" on LH bowl and 8" on RH bowl.

PROJECT/JOB INFORMATION:

Project/Job name: _____

Specifier: _____

Contractor: _____



SINK DIMENSIONS:

Model	Overall	Bowl (s)	Depth	Recommended Cabinet size
3253	35 x 17,5	LH 18 x 16 RH 15 x 16	10 8	39

- All dimensions are in inches
- Cutout template supplied with every sink and available on our web site

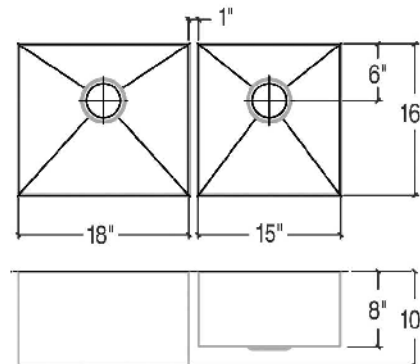

This specification is subject to change without notice. Julien assumes no responsibility for the use of superseded or voided specifications.