

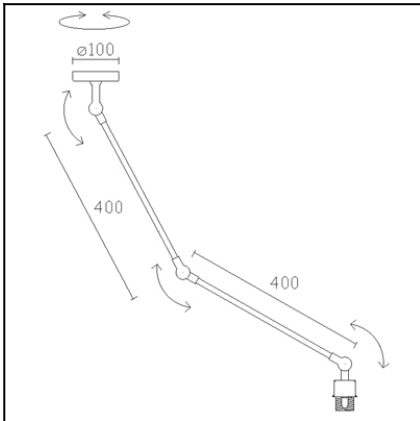

The photograph may not match the reference exactly. Please read the product description to identify the finish.



### TECHNICAL CHARACTERISTICS

Type:	Wall fixture/Pendant
Adjustable:	Adjustable 355° on the vertical axis. Adjustable 355° on the horizontal axis.
IP Protection degrees:	IP20
Light source 1:	1 x E27 MAX 100W Maximum lamp length: 125.00 mm
Total power consumption (W):	100
Voltage / Frequency:	220-240V/50-60Hz
Warranty (Years):	2
Units per box:	8
Net Weight (Kg):	0.815
EAN:	8435381409852



### MATERIALS / FINISHES

**Structure material:** Steel  
**Structure finish:** Satin nickel  
 Chrome

Download photometric file .ldt / .ies

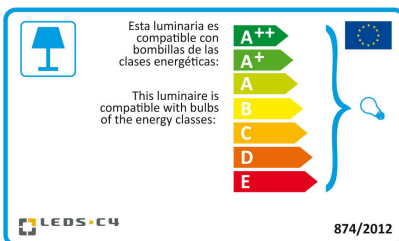

Click on image to download energy label

## PAN-163-05



Shade, black horizontal wrapping, Ø330mm

**Structure material:** Steel

**Diffuser material:** Ribbioned shade

**Diffuser finish:** Black

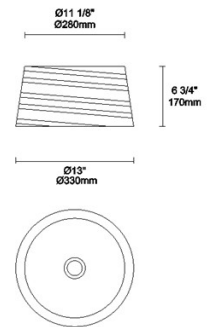

IP20 RF  
850°C

## PAN-163-14



Shade, white horizontal wrapping, Ø330mm

**Structure material:** Steel

**Diffuser material:** Ribbioned shade

**Diffuser finish:** White

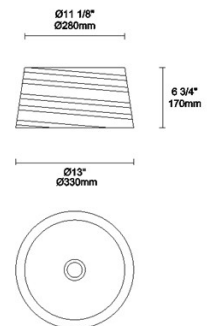

IP20 RF  
850°C

## PAN-164-05



Shade, black horizontal wrapping, Ø450mm

**Structure material:** Steel

**Diffuser material:** Ribbioned shade

**Diffuser finish:** Black

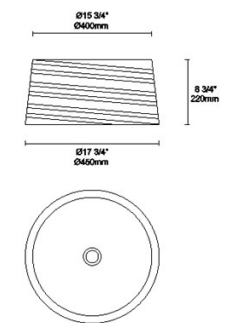

IP20 RF  
850°C

## PAN-164-14



Shade, white horizontal wrapping, Ø450mm

**Structure material:** Steel

**Diffuser material:** Ribbioned shade

**Diffuser finish:** White

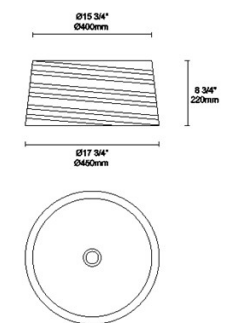

IP20 RF  
850°C

PAN-174-05



Shade, black, Ø450mm

**Structure material:** Steel  
**Diffuser material:** Fabric shade  
**Diffuser finish:** Black

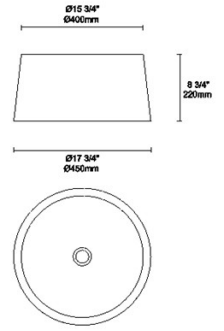

RF  
850°C

PAN-174-14



Shade, white, Ø450mm

**Structure material:** Steel  
**Diffuser material:** Fabric shade  
**Diffuser finish:** White

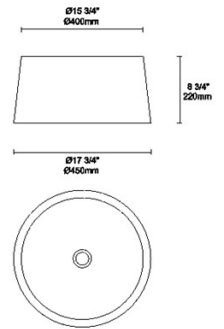

RF  
850°C

PAN-219-05



Shade, black horizontal wrapping, Ø200mm

**Structure material:** Steel  
**Structure finish:** White  
**Diffuser material:** Ribboned shade  
**Diffuser finish:** Black

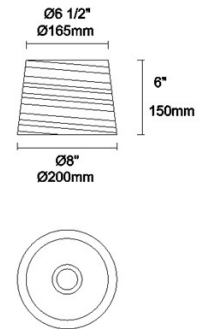

IP20 RF  
850°C

PAN-219-14



Shade, white, horizontal wrapping, Ø200mm

**Structure material:** Steel  
**Structure finish:** White  
**Diffuser material:** Ribboned shade  
**Diffuser finish:** White

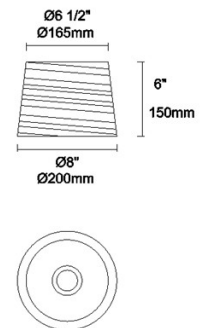

IP20 RF  
850°C

