

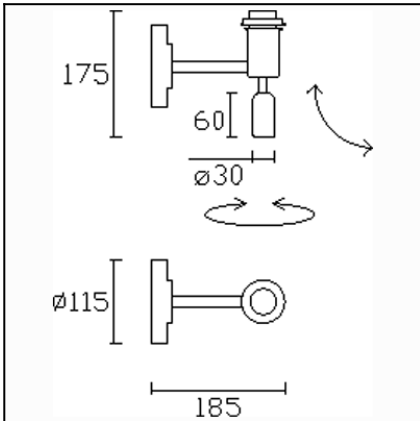

The photograph may not match the reference exactly. Please read the product description to identify the finish.

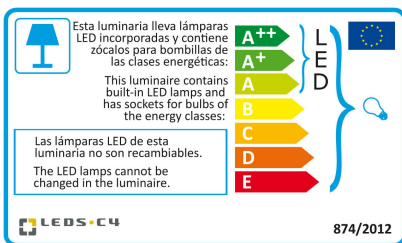

Download photometric file .ldt / .ies



Click on image to download energy label

### TECHNICAL CHARACTERISTICS

Type:	Wall fixture
Adjustable:	Adjustable 355° on the horizontal axis. Adjustable from 0° to 90° on the horizontal axis
IP Protection degrees:	IP20
Light source 1:	1 x E27 MAX 60W 107 lm <sup>(N)</sup>
Light source 3:	1 x LED Cree 1W
Voltage / Frequency:	100-240V/50-60Hz
Warranty (Years):	2
Option to extend the guarantee (Years):	5
Units per box:	8
Net Weight (Kg):	0.55
EAN:	8435381409982



### MATERIALS / FINISHES

**Structure material:** Steel  
**Structure finish:** BRIGHT WHITE

### GEAR

Gear included: Yes, electronic

Lm<sup>(N)</sup>: Nominal flow of light in actual working conditions. Its actual flow will depend on the environmental conditions and the efficiency of the optics and/or diffuser.

Leds-c4 reserves the right to make the necessary technical changes they deem adequate, in order to improve the features of the product.  
Please consult the sales team to clarify any doubt.

(+34) 973 468 100  
leds-c4@leds-c4.com  
www.leds-c4.com

**PAN-175-14**



Shade, white, Ø140mm

**Structure material:** Steel  
**Diffuser material:** Fabric shade  
**Diffuser finish:** White

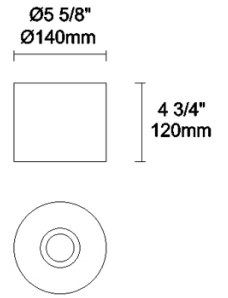

IP20 RF  
850°C

**PAN-175-BY**



Shade, beige fabric, Ø140mm

**Structure material:** Steel  
**Diffuser material:** Fabric shade  
**Diffuser finish:** Sandblasted

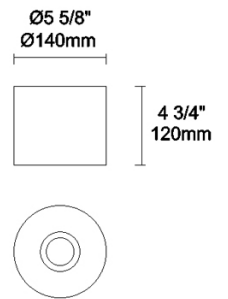

IP20 RF  
850°C

**PAN-177-14**



Shade, oval shape, white, 285x150x150mm

**Structure material:** Steel  
**Diffuser material:** Fabric shade  
**Diffuser finish:** White

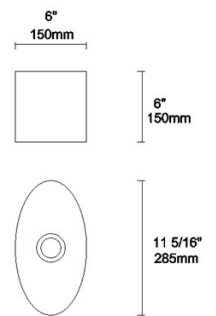

**PAN-177-BY**



Shade, oval shape, beige fabric, 285x150x150mm

**Structure material:** Steel  
**Diffuser material:** Fabric shade  
**Diffuser finish:** Sandblasted

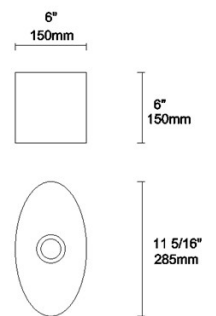

RF  
850°C

PAN-157-14



Shade, white, Ø200mm

**Structure material:** Steel  
**Diffuser material:** Fabric shade  
**Diffuser finish:** White

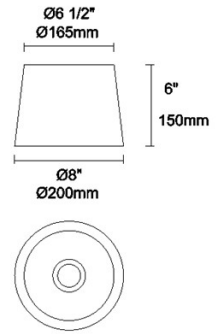

IP20 RF  
850°C

PAN-157-BY



**Structure material:** Steel  
**Diffuser material:** Fabric shade  
**Diffuser finish:** Sandblasted

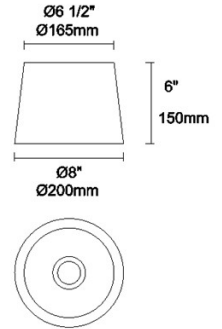

IP20 RF  
850°C

PAN-178-14



Shade, white, 130x130x110mm

**Structure material:** Steel  
**Diffuser material:** Fabric shade  
**Diffuser finish:** White

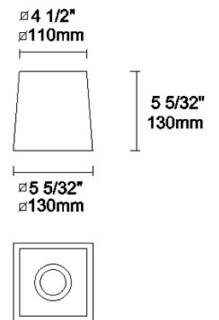

IP20 650°

PAN-178-BY



Shade, beige fabric, 130x130x110mm

**Structure material:** Steel  
**Diffuser material:** Fabric shade  
**Diffuser finish:** Sandblasted

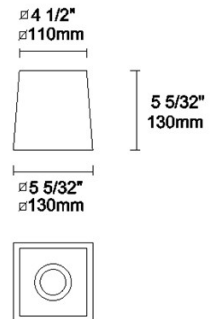

IP20 650°

PAN-186-20

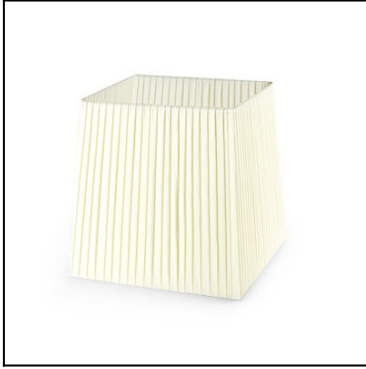

Shade, beige, pleated, 130x130x110mm

**Structure material:** Steel  
**Diffuser material:** Ribboned shade  
**Diffuser finish:** Beige

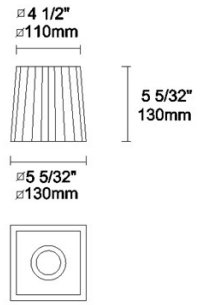

IP20 RF  
850°C

PAN-179-14



Shade, white, 180x186x150mm

**Structure material:** Steel  
**Diffuser material:** Fabric shade  
**Diffuser finish:** White

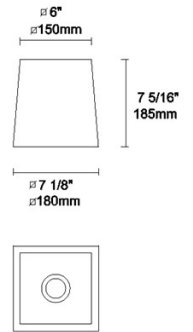

IP20 RF  
850°C

PAN-179-BY



Shade, beige fabric, 180x186x150mm

**Structure material:** Steel  
**Diffuser material:** Fabric shade  
**Diffuser finish:** Sandblasted

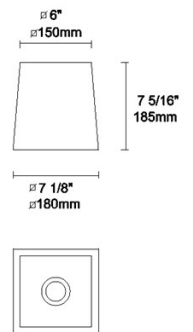

IP20 650°

PAN-187-20



Shade, beige, pleated, 180x186x150mm

**Structure material:** Steel  
**Diffuser material:** Ribboned shade  
**Diffuser finish:** Beige

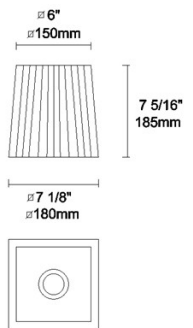

IP20 RF  
850°C

PAN-219-14



Shade, white, horizontal wrapping, Ø200mm

**Structure material:** Steel  
**Structure finish:** White

**Diffuser material:** Ribboned shade  
**Diffuser finish:** White

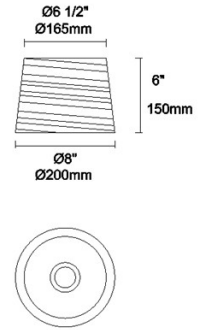

IP20 RF  
850°C

PAN-219-05



Shade, black horizontal wrapping, Ø200mm

**Structure material:** Steel  
**Structure finish:** White

**Diffuser material:** Ribboned shade  
**Diffuser finish:** Black

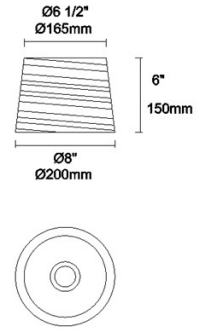

IP20 RF  
850°C

PAN-176-14

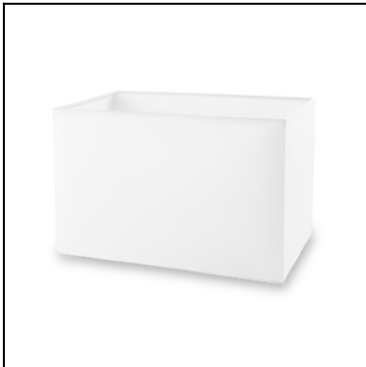

Shade, white, 182x170x150mm

**Structure material:** Steel

**Diffuser material:** Fabric shade  
**Diffuser finish:** White

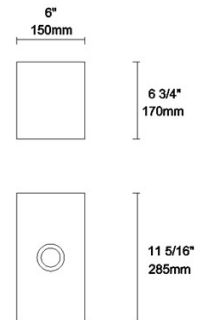

RF  
850°C

PAN-176-BY



Shade, beige fabric, 182x170x150mm

**Structure material:** Steel

**Diffuser material:** Fabric shade  
**Diffuser finish:** Sandblasted

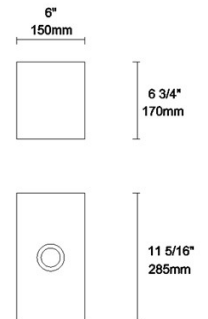

RF  
850°C

PAN-194-AJ



Shade, grey, Ø220mm

**Diffuser material:** Fabric shade  
**Diffuser finish:** Opera grey

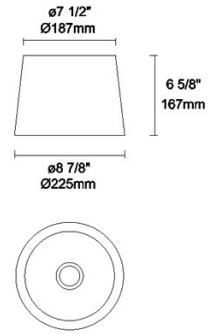

IP20

PAN-198-V7



Shade, old copper, Ø186mm

**Structure material:** Steel  
**Diffuser material:** PVC  
**Diffuser finish:** Antique copper

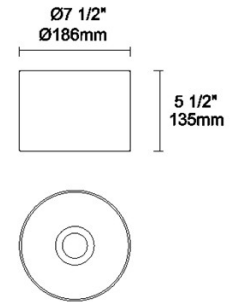

IP20 RF  
850°C

PAN-199-V7



Shade, old copper, Ø235mm

**Structure material:** Steel  
**Diffuser material:** PVC  
**Diffuser finish:** Antique copper

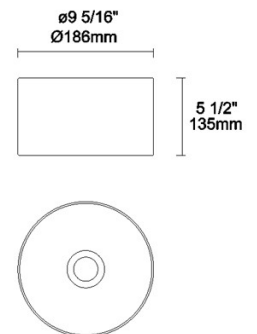

IP20 RF  
850°C

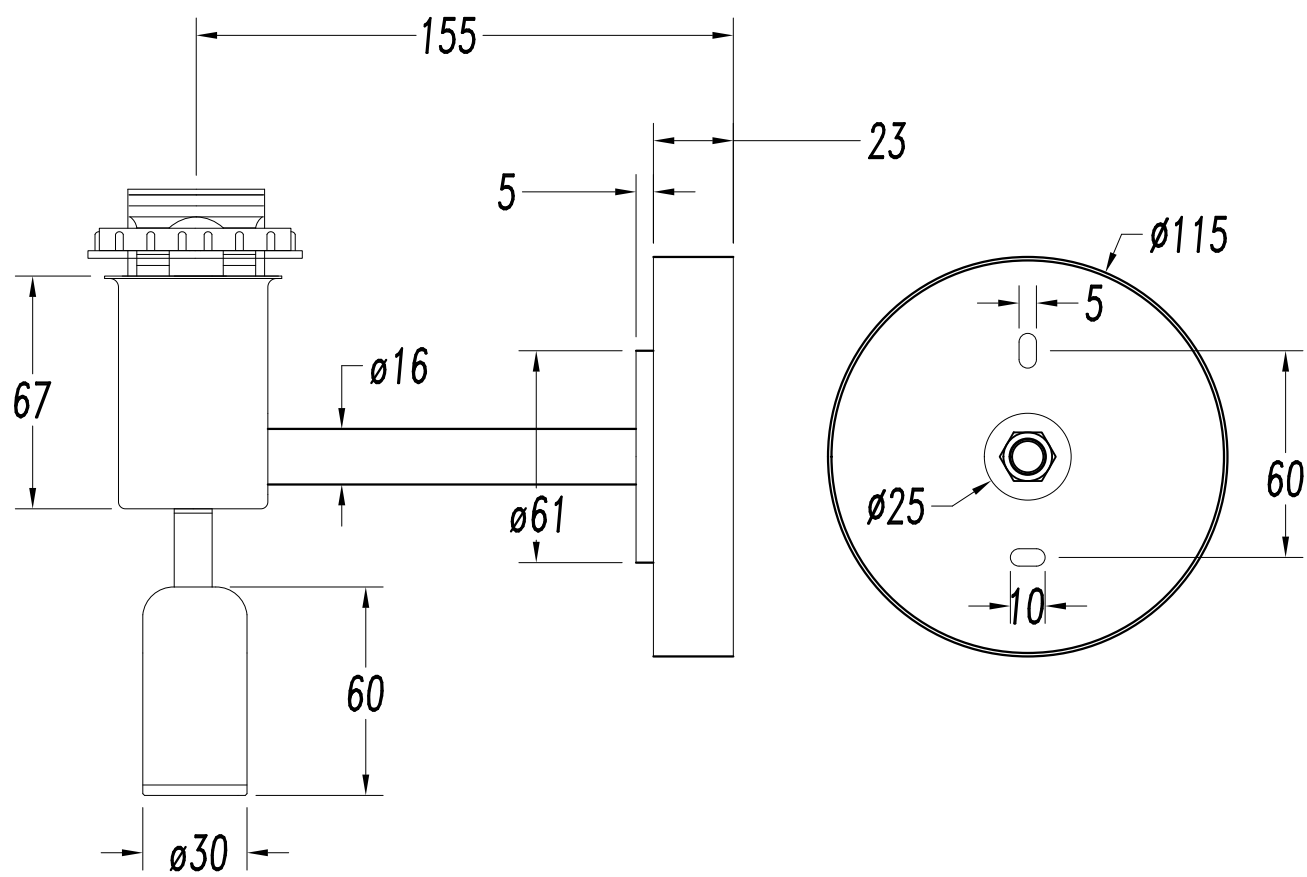

1

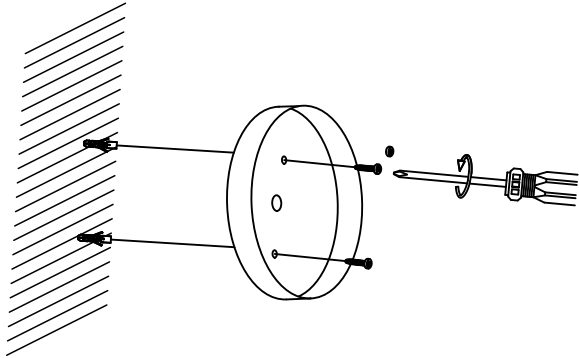
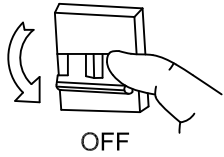

2

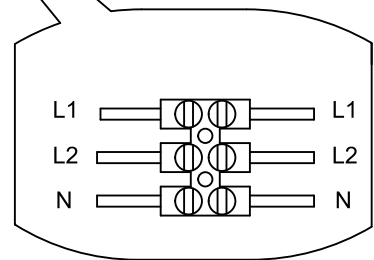
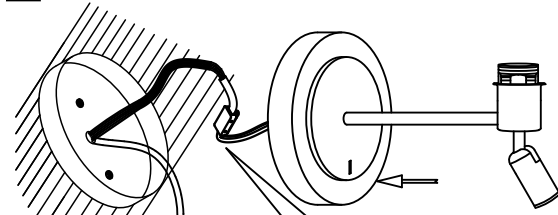

3

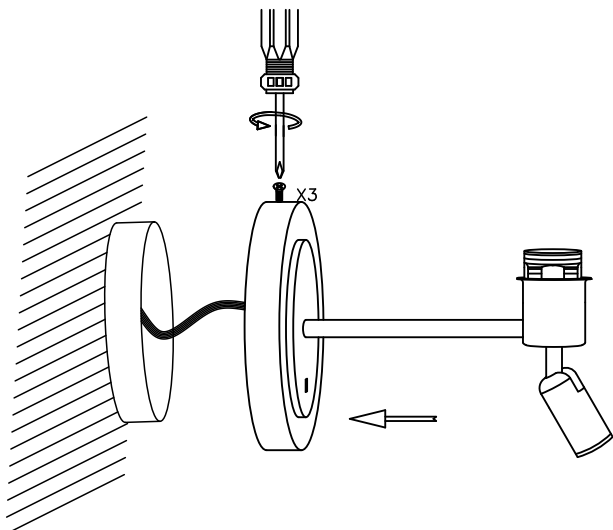

4

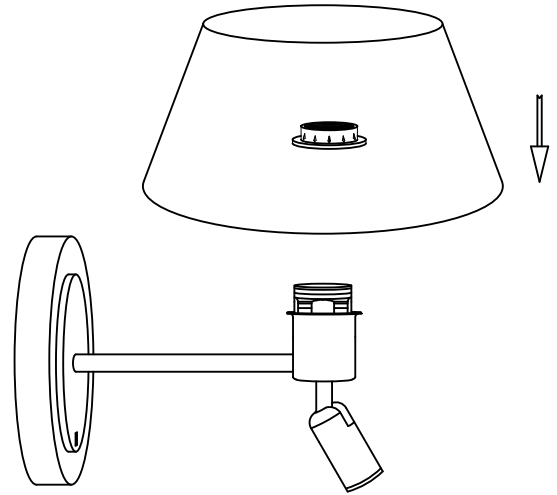

5

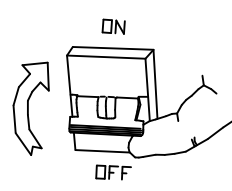
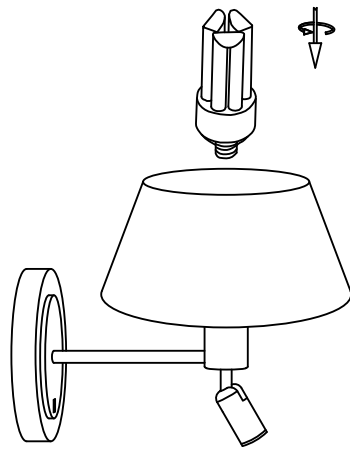

6

