

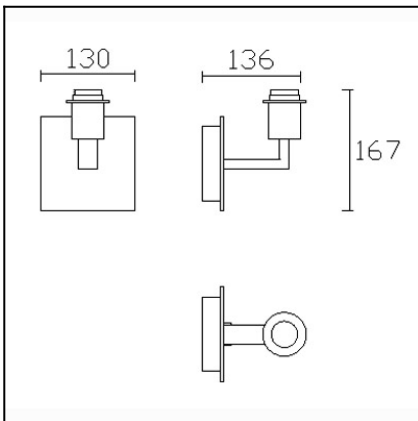

The photograph may not match the reference exactly. Please read the product description to identify the finish.

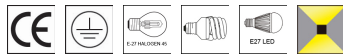

TECHNICAL CHARACTERISTICS

Type:	Wall fixture
IP Protection degrees:	IP20
Light source 1:	1 x E27 MAX 60W Maximum lamp diameter: 45.00 mm
Voltage / Frequency:	220-240V/50-60Hz
Warranty (Years):	2
Units per box:	8
Net Weight (Kg):	0.72
EAN:	8435381412425

MATERIALS / FINISHES

Structure material:	Steel Zamak
Structure finish:	Satin nickel

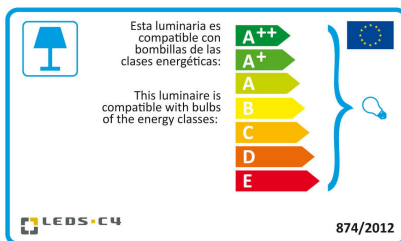
Download photometric file .ldt /.ies



Click on image to download energy label

PAN-175-14



Shade, white, Ø140mm

Structure material: Steel
Diffuser material: Fabric shade
Diffuser finish: White

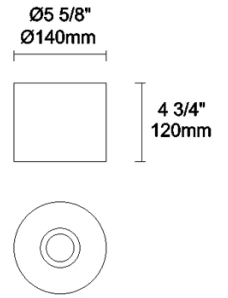

IP20 RF
850°C

PAN-175-BY



Shade, beige fabric, Ø140mm

Structure material: Steel
Diffuser material: Fabric shade
Diffuser finish: Sandblasted

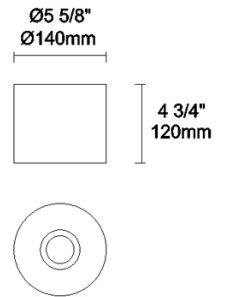

IP20 RF
850°C

PAN-177-14



Shade, oval shape, white, 285x150x150mm

Structure material: Steel
Diffuser material: Fabric shade
Diffuser finish: White

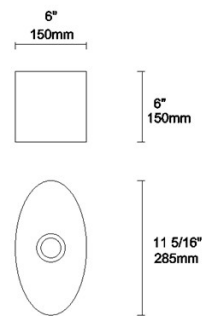

PAN-177-BY



Shade, oval shape, beige fabric, 285x150x150mm

Structure material: Steel
Diffuser material: Fabric shade
Diffuser finish: Sandblasted

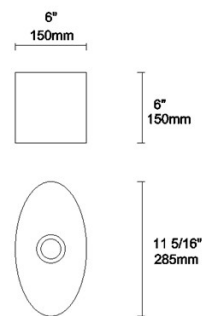

RF
850°C

PAN-157-14



Shade, white, Ø200mm

Structure material: Steel

Diffuser material: Fabric shade

Diffuser finish: White

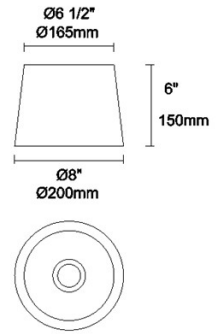

IP20 RF
850°C

PAN-157-BY



Structure material: Steel

Diffuser material: Fabric shade

Diffuser finish: Sandblasted

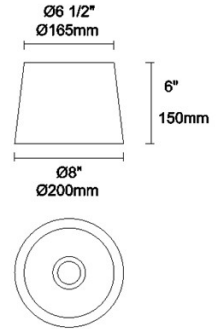

IP20 RF
850°C

PAN-219-14



Shade, white, horizontal wrapping, Ø200mm

Structure material: Steel

Structure finish: White

Diffuser material: Ribboned shade

Diffuser finish: White

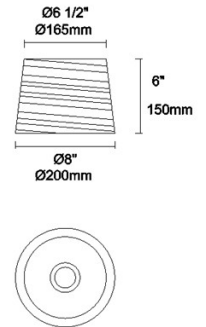

IP20 RF
850°C

PAN-219-05



Shade, black horizontal wrapping, Ø200mm

Structure material: Steel

Structure finish: White

Diffuser material: Ribboned shade

Diffuser finish: Black

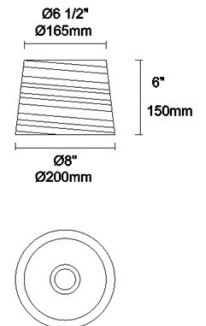

IP20 RF
850°C

PAN-178-14



Shade, white, 130x130x110mm

Structure material: Steel
Diffuser material: Fabric shade
Diffuser finish: White

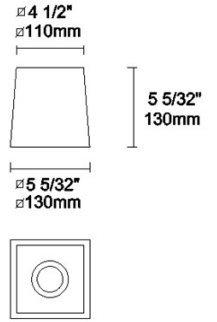

IP20 650°

PAN-178-BY



Shade, beige fabric, 130x130x110mm

Structure material: Steel
Diffuser material: Fabric shade
Diffuser finish: Sandblasted

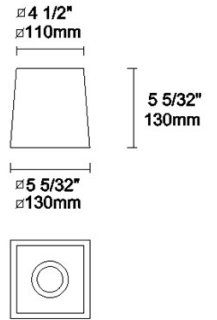

IP20 650°

PAN-186-20

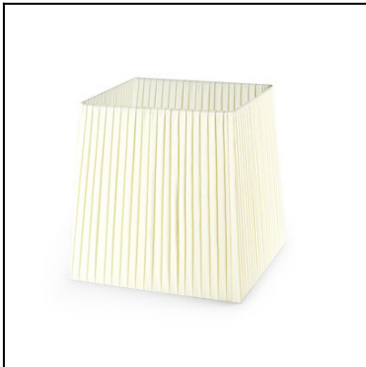

Shade, beige, pleated, 130x130x110mm

Structure material: Steel
Diffuser material: Ribbed shade
Diffuser finish: Beige

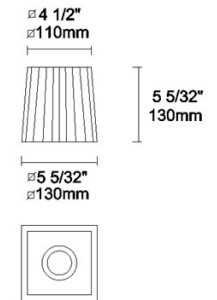

IP20 RF
850°c

PAN-176-14

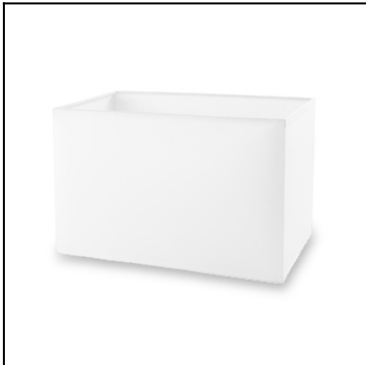

Shade, white, 182x170x150mm

Structure material: Steel
Diffuser material: Fabric shade
Diffuser finish: White

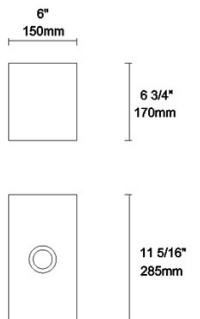

RF
850°c

PAN-176-BY



Shade, beige fabric, 182x170x150mm

Structure material: Steel
Diffuser material: Fabric shade
Diffuser finish: Sandblasted

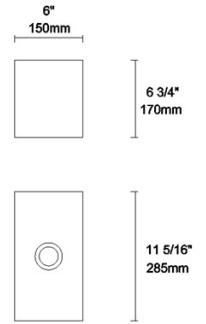

RF
850°C

PAN-198-V7



Shade, old copper, Ø186mm

Structure material: Steel
Diffuser material: PVC
Diffuser finish: Antique copper

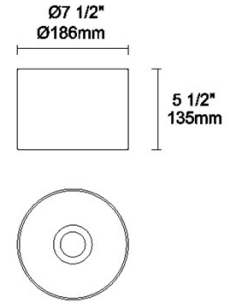

IP20 RF
850°C

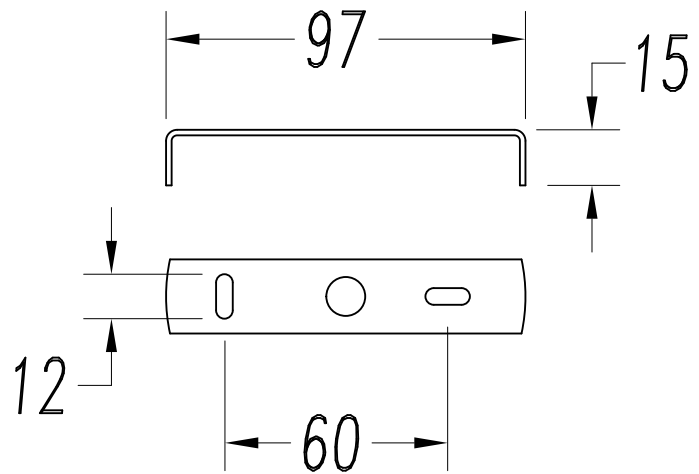
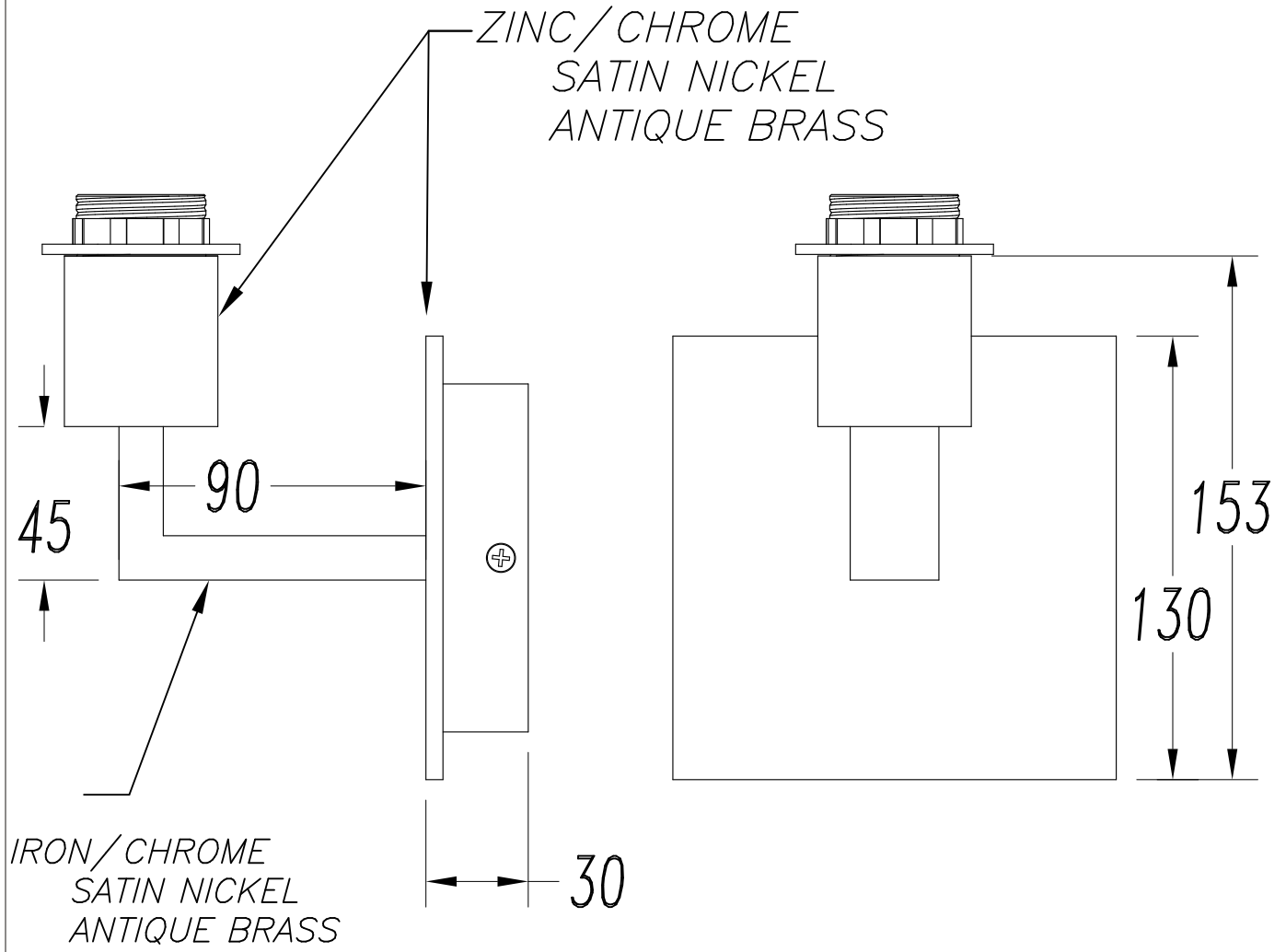

1

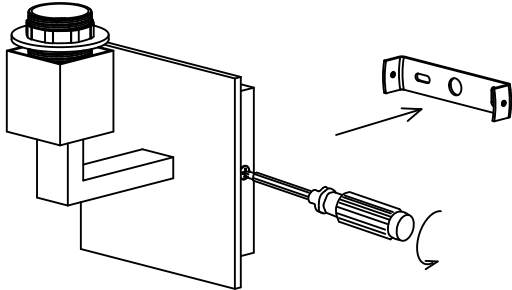

2

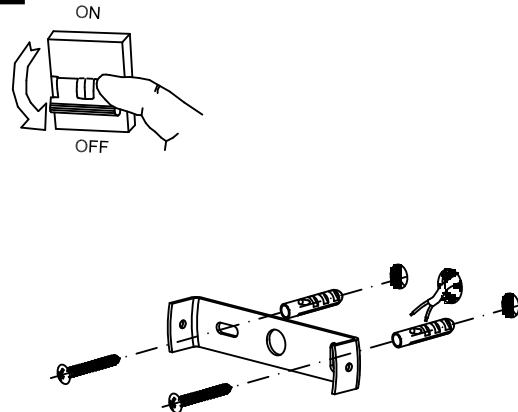

3

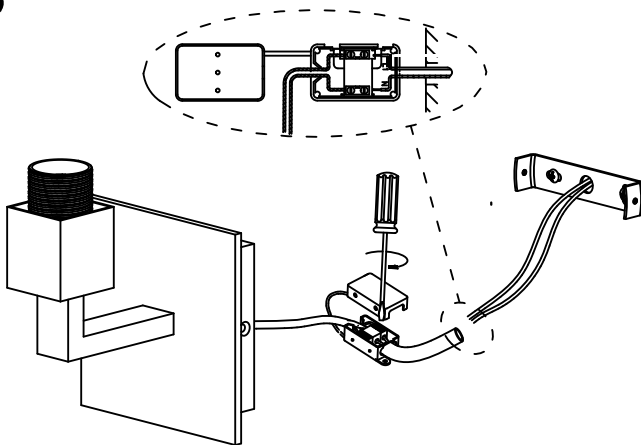

4

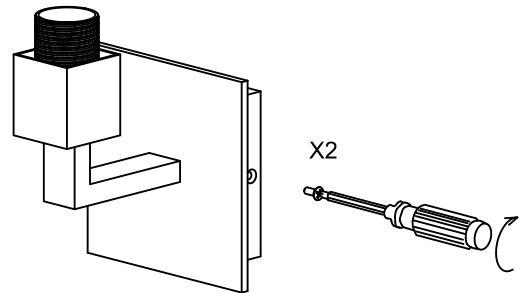

5

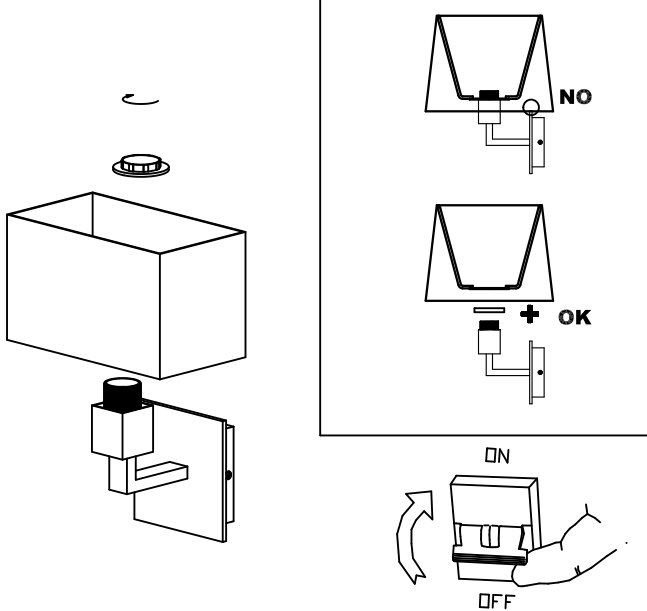

6

