

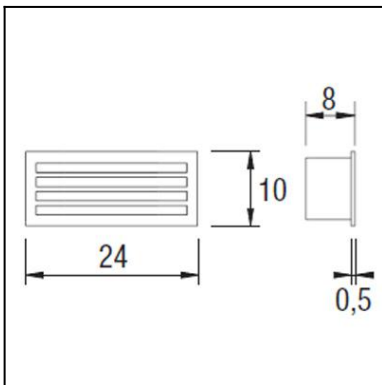

The photograph may not match the reference exactly. Please read the product description to identify the finish.



TECHNICAL CHARACTERISTICS

Type:	WALL RECESSED
IP Protection degrees:	IP44
IK Protection degrees:	IK08
Light source 1:	1 x E27 MAX 60W Maximum lamp length: 145.00 mm Maximum lamp diameter: 45.00 mm
Total power consumption (W):	60
Voltage / Frequency:	230V/50-60Hz
Warranty (Years):	2
Units per box:	18
Net Weight (Kg):	0.89
EAN:	8435111089330



MATERIALS / FINISHES

Structure material: Stainless steel AISI316

Diffuser material: Glass

Structure finish: Polished

Diffuser finish: Matt

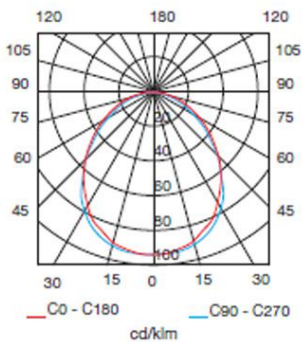

Download photometric file .ldt / .ies

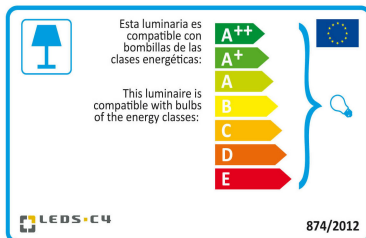

Click on image to download energy label

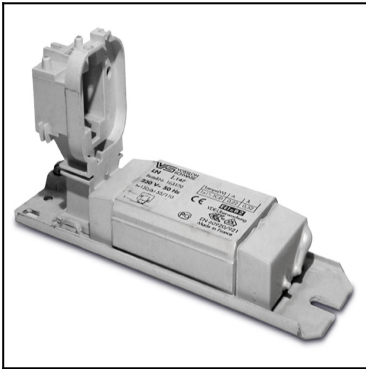
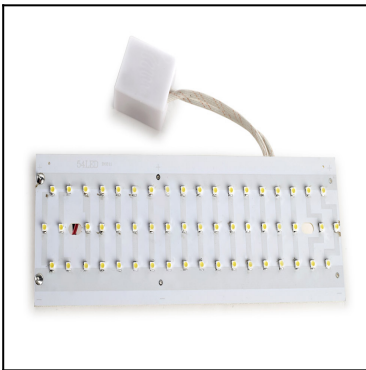
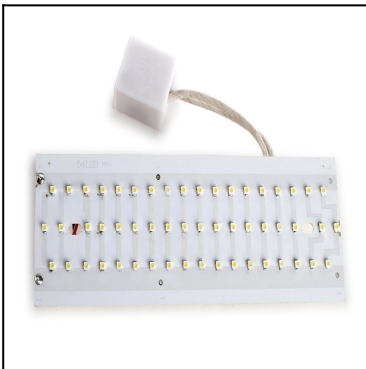
71-8969-00-00**71-9713-00-00****71-9714-00-00**

Luminaire		Measur.		Lamp		
Code	05-9212-Y4-T2	Code	05-9212-Y4-T2	Code	PL-C13W/840/2P	
Name	Aplique 1x13W TC-D dif rejilla	Name	Aplique 1x13W TC-D dif rejilla	Number	1	
Line	Eulumdat	Date	18-11-2008	Position		
Efficiency	23.17%	Coordinate system	CG	Total Flux	900.00 lm	
Maximum value	84.42 cd	Position	C=0.00 G=0.00	Double Symmetrical		
Rectangular Luminaire	Length	100 mm	Width	235 mm	Height	5 mm
Rectangular Luminous Area	Length	70 mm	Width	200 mm	Height	1 mm
Horizontal Luminous Area	0.014000 m2	Emitting area on Plane 180°		0.000070 m2		
Emitting area on Plane 0°	0.000070 m2	Emitting area on Plane 270°		0.000200 m2		
Emitting area on Plane 90°	0.000200 m2	Glare area at 76°		0.003455 m2		
Symmetry Type	Double Symmetrical	Maximum Gamma Angle	90			
Measurement Distance	0.00	Measurement Flux	900.00 lm			
Operator	OxyTech	Source voltage				
Temperature	25.00 °C	Source current				
Humidity	60.00 %	Photocell				
Notes						

Luminaire Lamps						
Line	Code	Name	Flux [lm]	Pow. [W]	Q.ty	
Eulumdat	PL-C13W/840/2P	PL-C13W/840/2P - 13.00 W	900.00	13.00	1	
C.I.E.	52 83 96 100 23	D DIN 5040	A40			
F UTE	0.23 D	B NBN	BZ 4			

100mm x 235mm

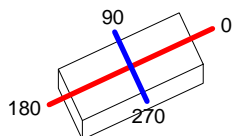

C Halfplanes

180.0 — 0.0

270.0 — 90.0

ULOR 0.00 %

DLOR 23.17 %

RN 0.00 %

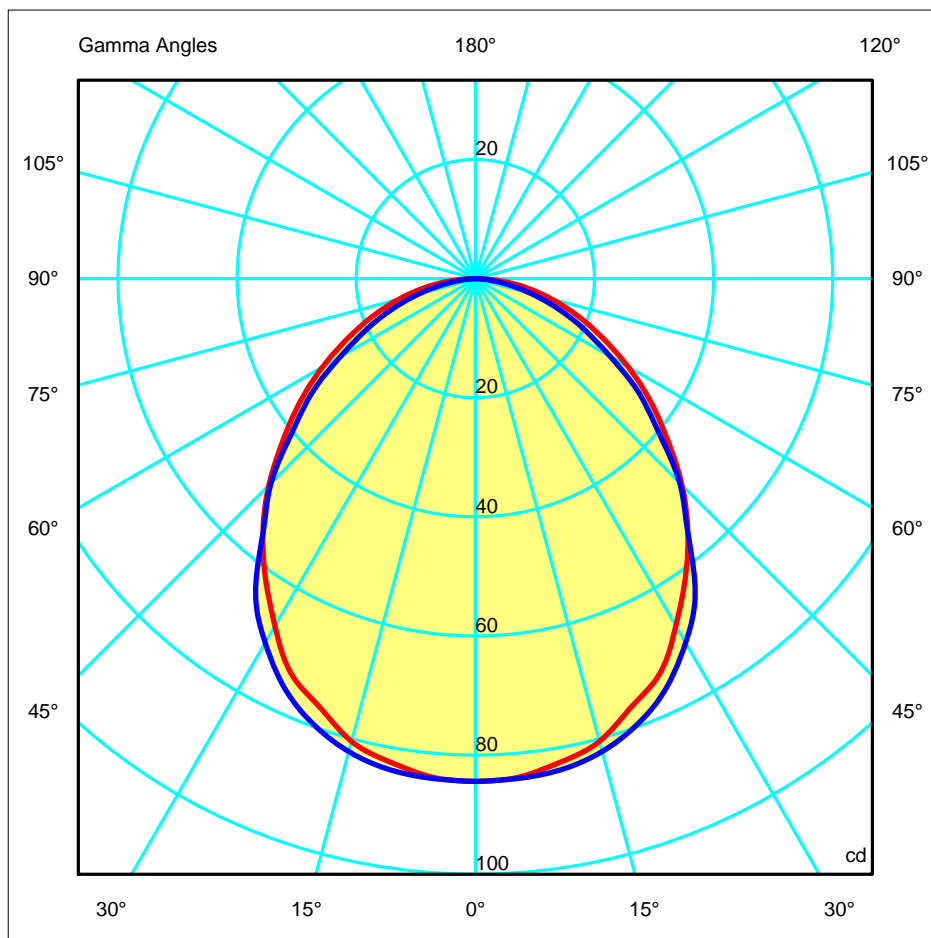

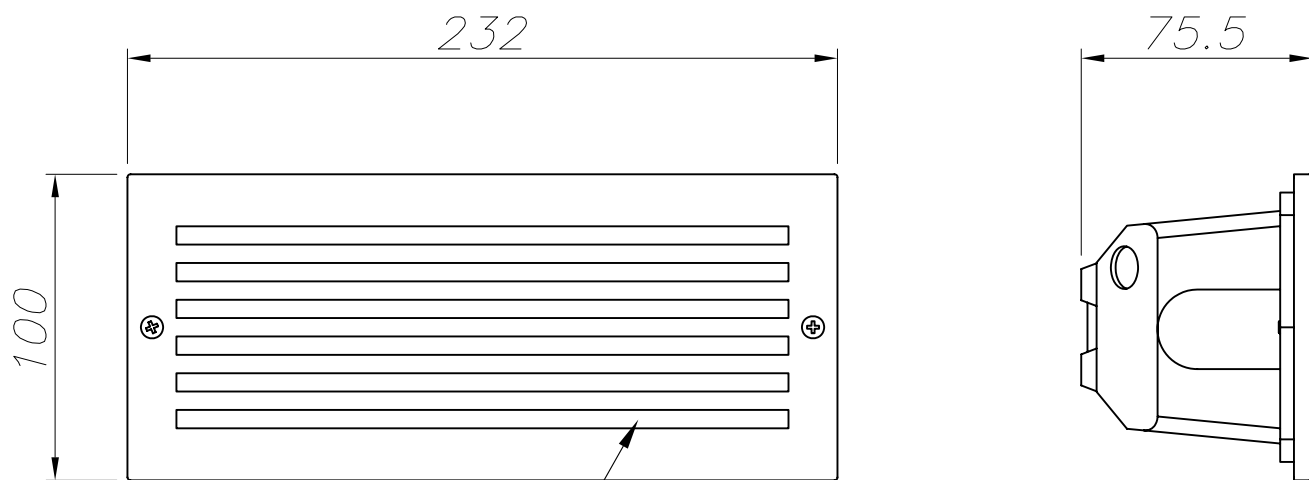

CRISTAL ARENADO INTERIOR
SANDFROSTED GLASS INSIDE

ACERO INOXIDABLE AISI 316
STAINLESS STEEL AISI 316

ALUMINIO INYECTADO
INJECTED ALUMINIUM

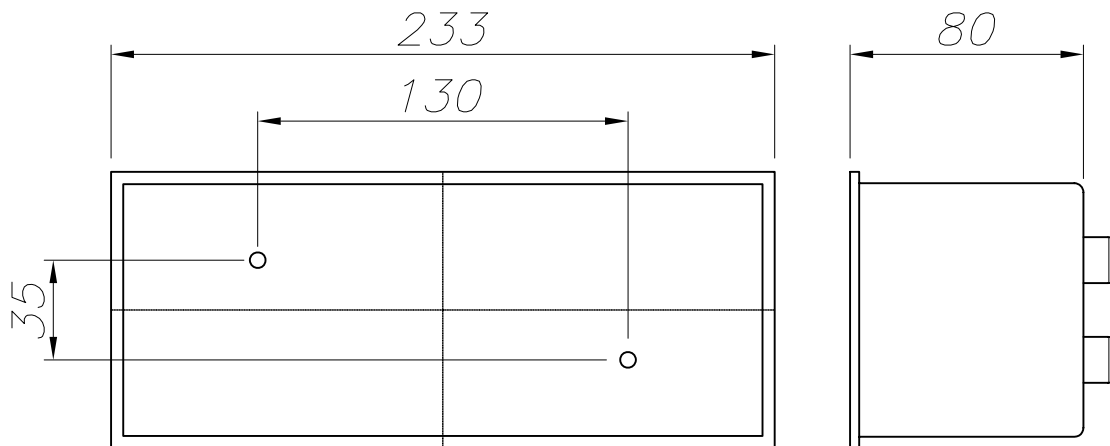
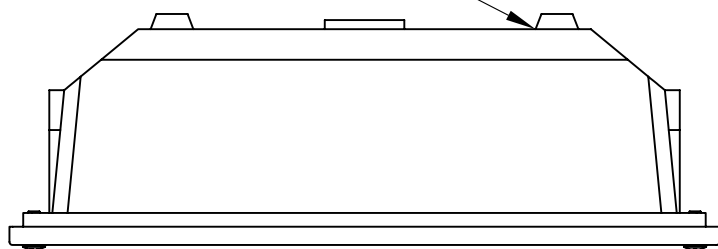

CAJA DE EMPOTRAR
FLUSH FITTING BOX

