

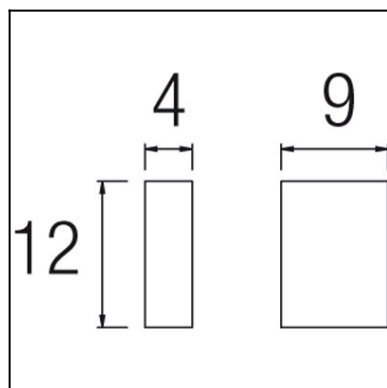

The photograph may not match the reference exactly. Please read the product description to identify the finish.



TECHNICAL CHARACTERISTICS

Type:	Wall fixture
IP Protection degrees:	IP44
Light source 1:	2 x LED Cree 4,5W Neutral white - 4000K 368 lm ^(N) CRI 75
Voltage / Frequency:	100-240V/50-60Hz
Warranty (Years):	2
Option to extend the guarantee (Years):	5
Units per box:	12
Net Weight (Kg):	0.595
EAN:	8435111088678



MATERIALS / FINISHES

Structure material:	Injected aluminium	Diffuser material:	Glass
Structure finish:	Grey	Diffuser finish:	Transparent

GEAR

Multi-voltage electronic gear included (110-240 V / 50-60 Hz)

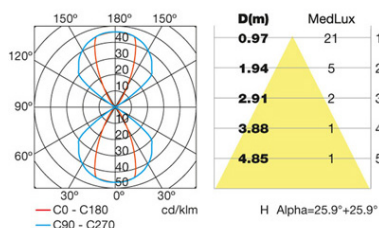

Download photometric file .ldt /.ies

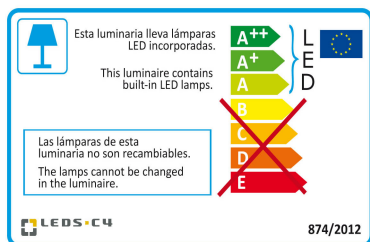

Click on image to download energy label

Lm^(N): Nominal flow of light in actual working conditions. Its actual flow will depend on the environmental conditions and the efficiency of the optics and/or diffuser.

LEDS-C4 reserves the right to make the necessary technical changes they deem adequate, in order to improve the features of the product.

Please consult the sales team to clarify any doubt.

Luminaire		Measur.		Lamp		
Code	05-9593	Code	05-9593	Code	05-9593	
Name	Aplique dir/ind. 2 leds	Name	Aplique dir/ind. 2 leds	Number	1	
Line	Eulumdat	Date	15-11-2011	Position		
Efficiency	100.00%	Coordinate system	CG	Total Flux	129.20 lm	
Maximum value	46.39 cd	Position	C=0.00 G=0.00	Double Symmetrical		
Rectangular Luminaire	Length	90 mm	Width	40 mm	Height	125 mm
Rectangular Luminous Area	Length	62 mm	Width	25 mm	Height	125 mm
Horizontal Luminous Area	0.001550 m2	Emitting area on Plane 180°		0.007750 m2		
Emitting area on Plane 0°	0.007750 m2	Emitting area on Plane 270°		0.003125 m2		
Emitting area on Plane 90°	0.003125 m2	Glare area at 76°		0.007895 m2		
Symmetry Type	Double Symmetrical	Maximum Gamma Angle	180			
Measurement Distance	0.00	Measurement Flux	129.20 lm			
Operator	Asselum T2	Source voltage				
Temperature	25.00 °C	Source current				
Humidity	60.00 %	Photocell				
Notes						

		Luminaire Lamps					
Line	Code	Name	Flux [lm]	Pow. [W]	Q.ty		
Eulumdat	05-9593	05-9593 - 6.00 W	129.20	6.00	1		
C.I.E.	76 97 99 50 100	D DIN 5040	C61				
F UTE	0.50 B + 0.50 T	B NBN	BZ 1				

90mm x 40mm

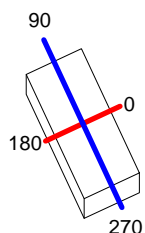

C Halfplanes

180.0 — 0.0

270.0 — 90.0

ULOR 50.00 %

DLOR 50.00 %

RN 50.00 %

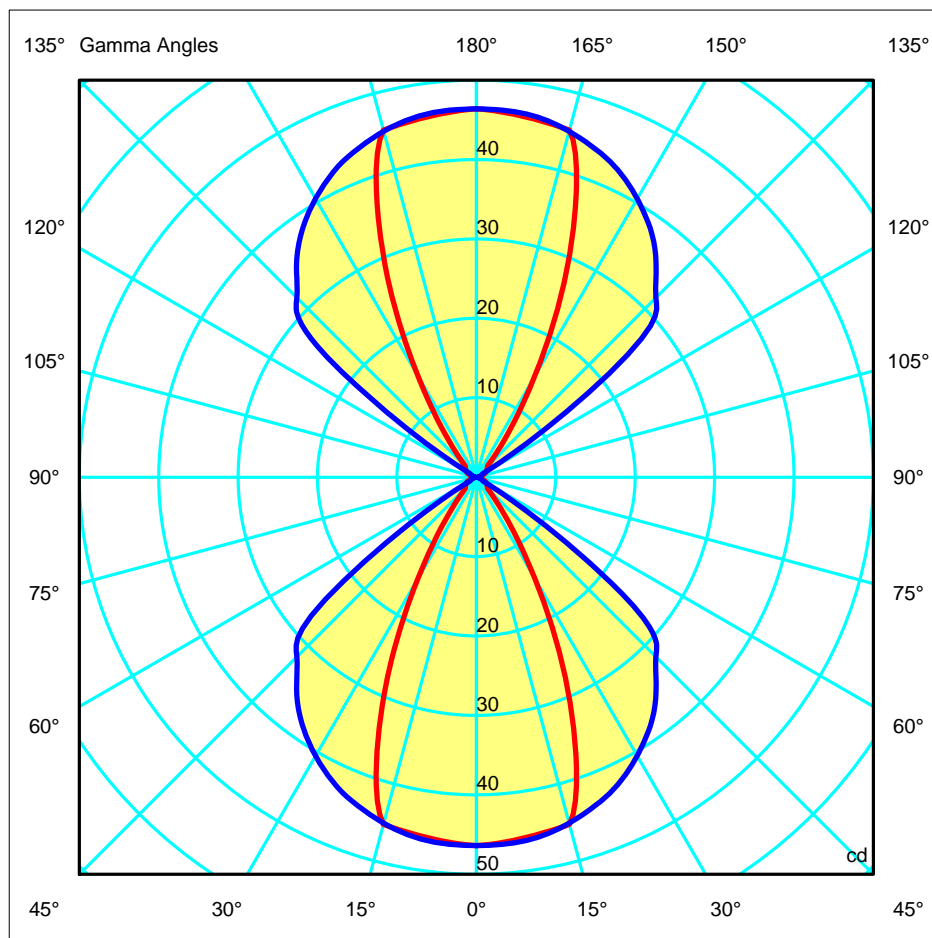

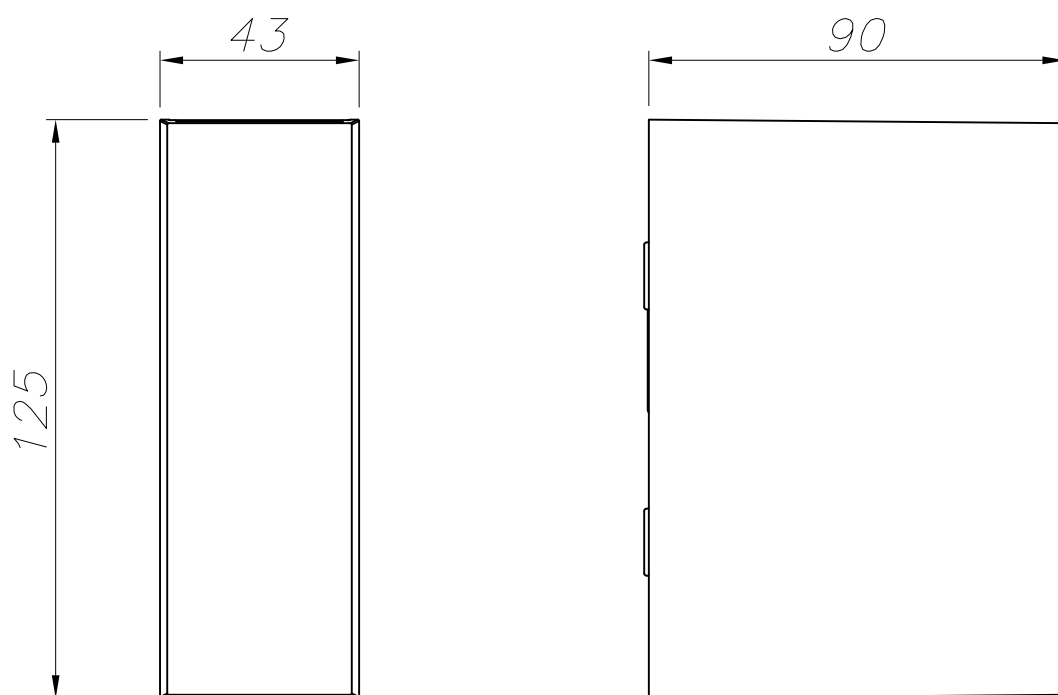

ALUMINIO INYECTADO
INJECTED ALUMINIUM

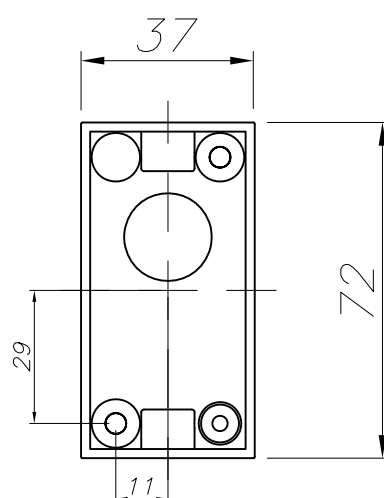

PLANTILLA DE INSTALACIÓN
INSTALLATION TEMPLATE

