

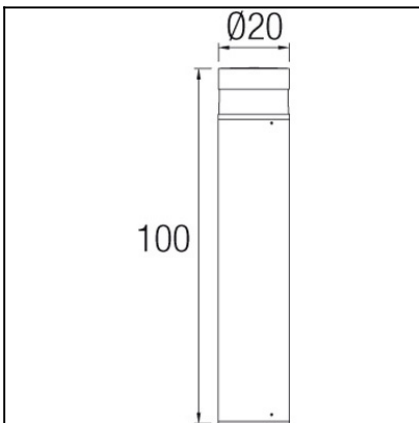

The photograph may not match the reference exactly. Please read the product description to identify the finish.



DESCRIPTION

Straight edged lamp designed for lighting vertical surfaces. Injected aluminium body and tempered glass diffuser. Available in various sizes and finishes: white, light grey, dark grey and brown. Available in different wattages for metal halide lamps, LED and fluorescent lights.

TECHNICAL CHARACTERISTICS

Type:	Beacon
IP Protection degrees:	IP54
IK Protection degrees:	IK10
Lampholder:	1 x G12
Power (W):	G12 70W
Voltage / Frequency:	230V/50Hz
Units per box:	1
Net Weight (Kg):	7.49
EAN:	8435111093184



MATERIALS / FINISHES

Structure material: Extruded aluminium

Diffuser material: Polycarbonate

Structure finish: Grey

Diffuser finish: Transparent

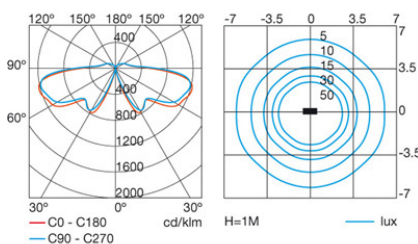

GEAR

Gear included: Yes, Magnetic