

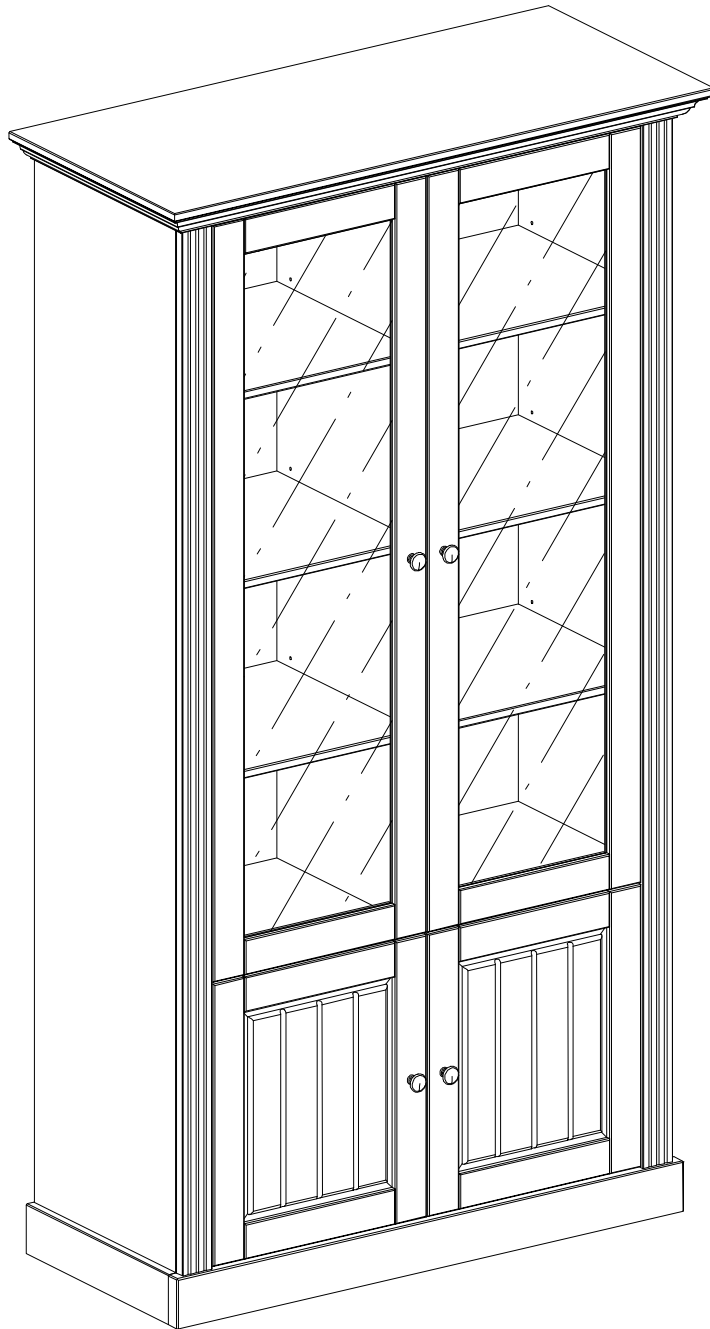

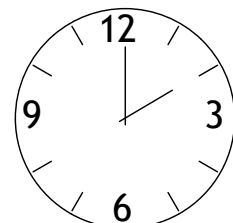

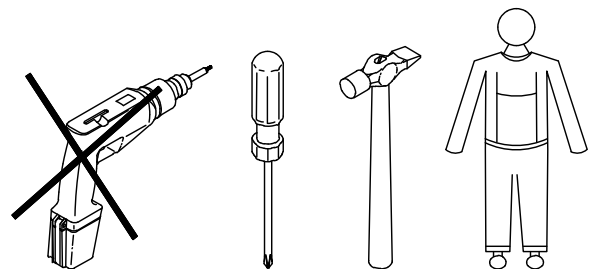

31712713

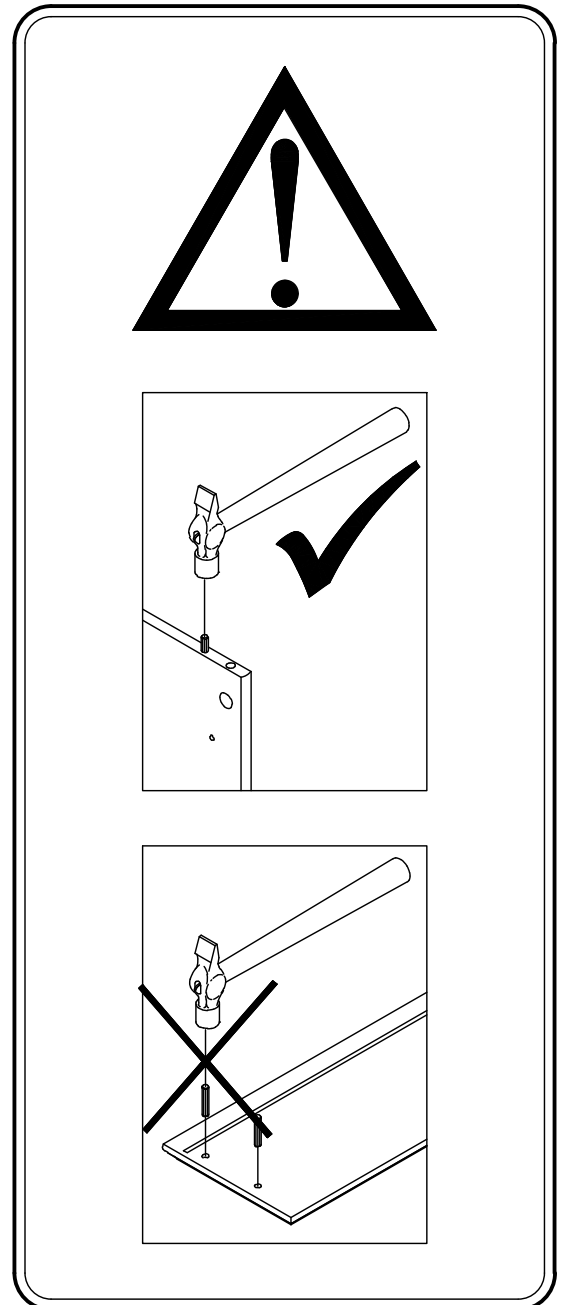
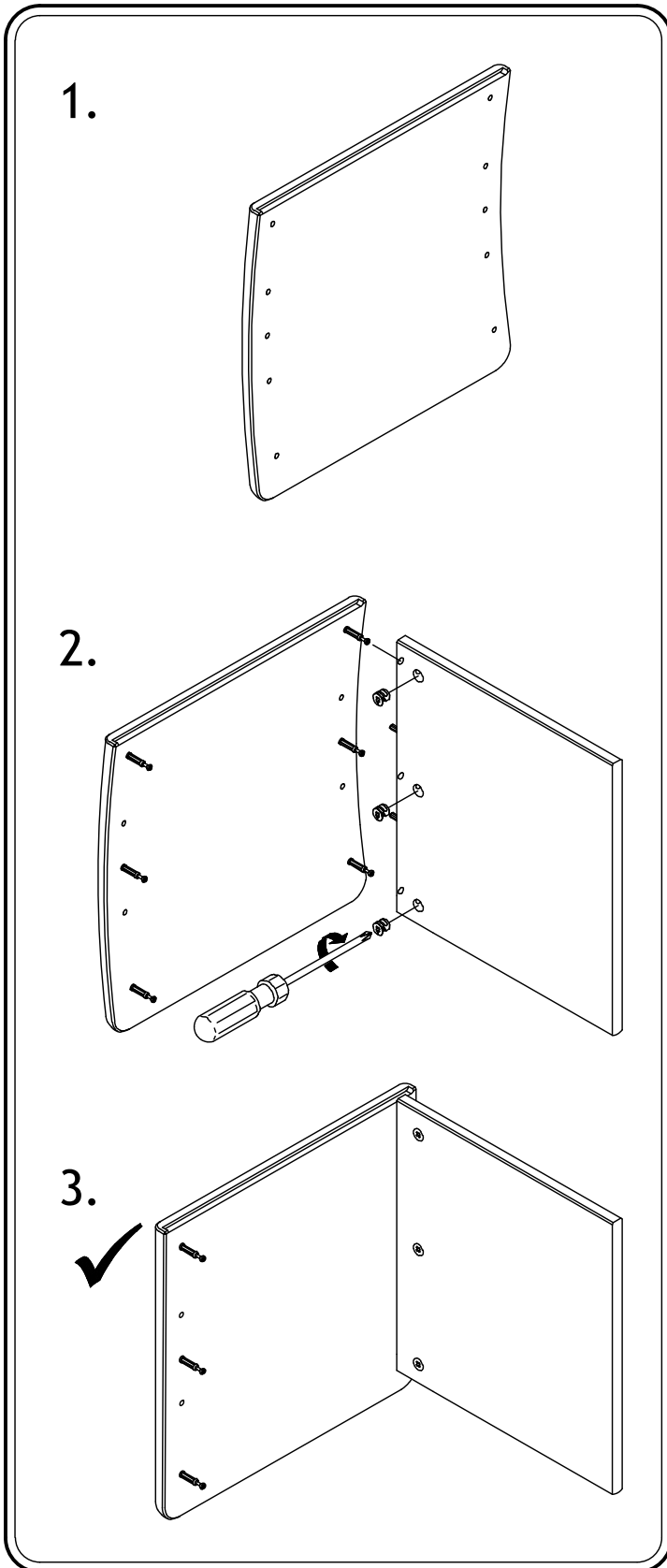
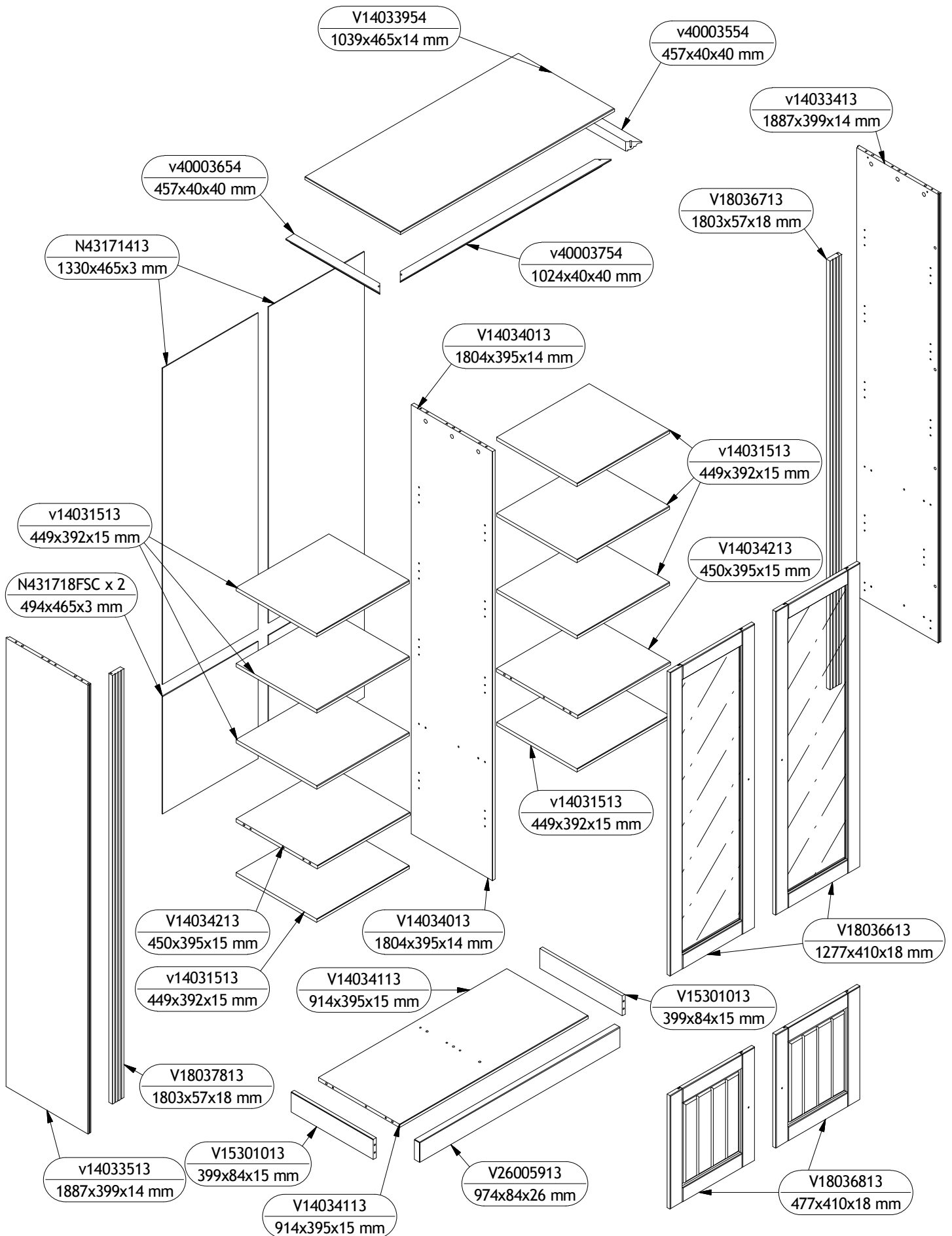
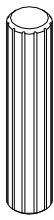

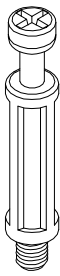
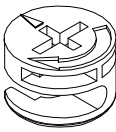

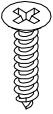
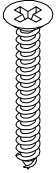
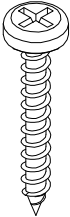
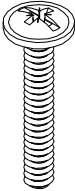
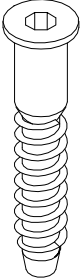

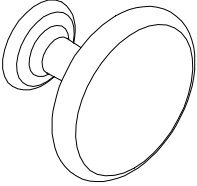
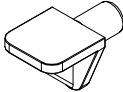
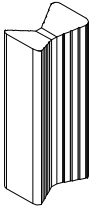
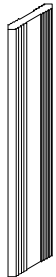
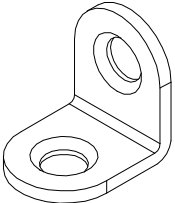
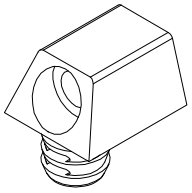
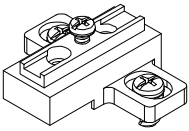
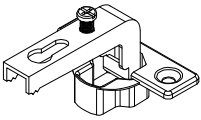
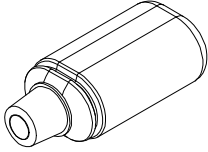
<p>BA10400 x 37 ø6x30</p> 	<p>BA10602 x 17 ø5/8x34</p> 	<p>BA10617 x 4 M4x5,5</p> 	<p>BA10590 x 21 ø15x9,5</p> 	<p>BA10020 x 75 ø1,2x16</p> 	<p>BA10250 x 2 6,3x11</p> 
<p>BA10050 x 18 ø3,5x15</p> 	<p>BA10110 x 8 ø3,5x25</p> 	<p>BA10144 x 10 ø4,5x30</p> 	<p>BA10223 x 4 M4x22/23</p> 	<p>BA10300 x 3 7x40</p> 	<p>BA10619 x 2 M4xø5x12</p> 
<p>BA10501 x 4 ø30x23,5</p> 	<p>BA10848 x 32 ø5x7</p> 	<p>BA10985 x 2 W-2 25,4 mm</p> 	<p>BA10981 x 14 3x16,5x80</p> 	<p>BA10801 x 2 20x20x16x2</p> 	<p>BA10336 x 10 22x12/ø11x10</p> 
<p>BA10536 x 8</p> 	<p>BA10535 x 8</p> 	<p>I10882 x 1</p> 	<p>BA10680 x 1 4 mm</p> 