











# MODEL : OLIVER BUNK BED

## ASSEMBLY INSTRUCTION

### PART LIST

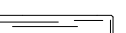
NO	DESCRIPTION	QTY
A	TOP HEADBOARD	2 PCS
B	BOTTOM HEADBOARD	2 PCS
C	LONG RAILS	4 PCS
D	FRONT GUARD RAIL	2 PCS
E	BACK GUARD RAIL	2 PCS
F	GUARD RAIL SUPPORT	3 PCS
G	LADDER LONG RAIL	1 PC
H	LADDER SHORT RAILS	2 PCS
i	BED SLATS	2 SETS

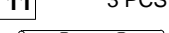
### HARDWARE LIST

<b>1</b>	1 PC	<b>2</b>	1 PC
	M4 ALLEN KEY		M4 ALLEN KEY (SHORT)
<b>3</b>	24 PCS	<b>4</b>	8 PCS
	JCBC M6x80mm		JCBC M6x45mm
<b>5</b>	4 PCS	<b>6</b>	9 PCS
	JCBC M6x35mm		JCBC M6x25mm
<b>7</b>	24 PCS	<b>8</b>	16 PCS
	BARREL NUT M6x15mm		WOOD DOWEL M8x35mm
<b>9</b>	60 PCS	<b>10</b>	15 PCS
	WOOD SCREW M4x25mm		JCN M6x15mm
<b>11</b>	3 PCS	<b>12</b>	1 PC
	METAL ROD M10x120mm		METAL ROD M10x40mm

### STEP 1 ( TOP BUNK BED )

#### ASSEMBLE LONG RAILS & BACK GUARD RAILS

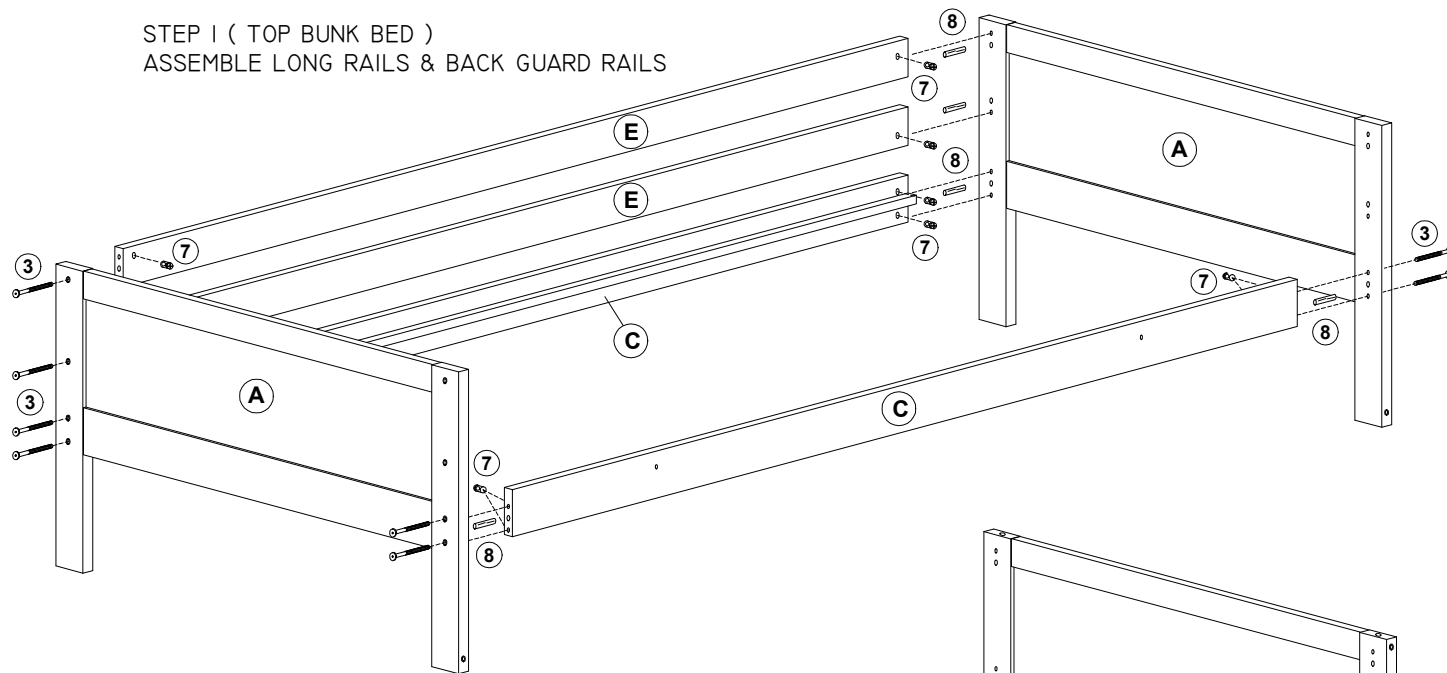

### STEP 2 ( BOTTOM BUNK BED )

#### ASSEMBLE LONG RAILS & BACK GUARD RAILS

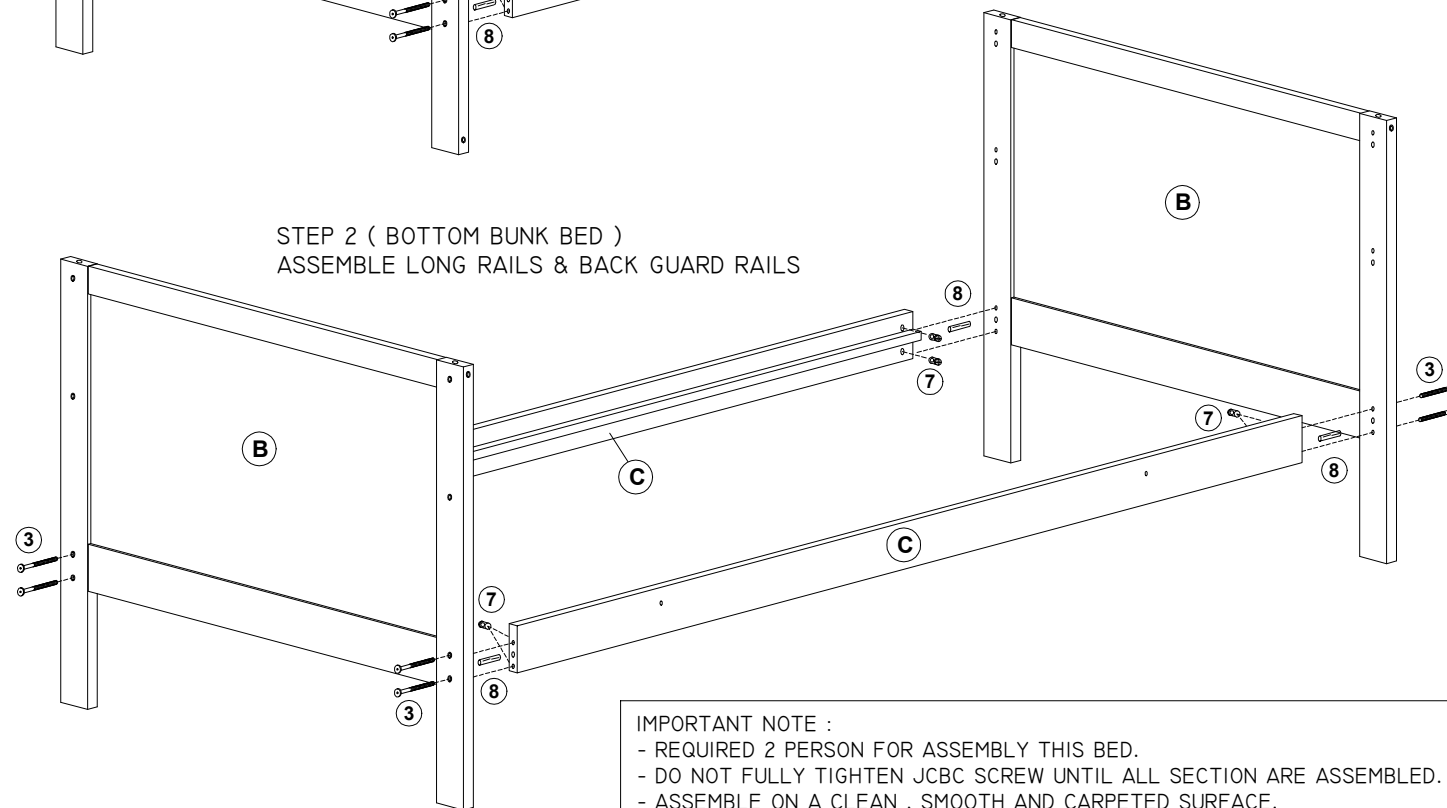

#### IMPORTANT NOTE :

- REQUIRED 2 PERSON FOR ASSEMBLY THIS BED.
- DO NOT FULLY TIGHTEN JCBC SCREW UNTIL ALL SECTION ARE ASSEMBLED.
- ASSEMBLE ON A CLEAN , SMOOTH AND CARPETED SURFACE.