

Drawbridge Multimedia Cabinet

240 CD / 108 DVD / 132 Blu-ray

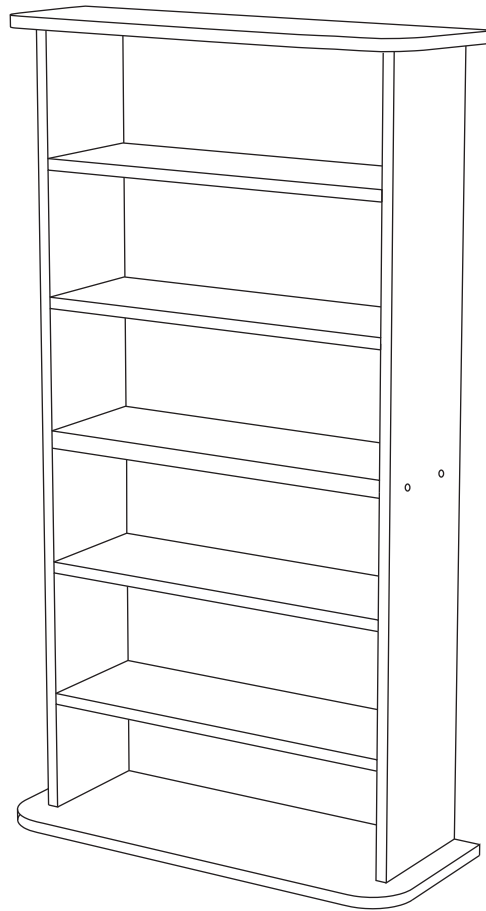

#37935622



Assembly instructions / Directives d'assemblage / Instrucciones de ensamble:

| Parts List / Lista de Componentes / Liste des pieces: | | Qty. Cant. / Qté / |
|---|--|--------------------------|
| (A) | | 2 |
| (B) | | 1 |
| (C) | | 1 |
| (D) | | 4 |
| (E) | | 1 |
| (F) | | 1 |

| Hardware / Herrajes / Matériel: | | Qty. Cant. / Qté / |
|------------------------------------|--|--------------------------|
| (1) | | 12 |
| (2) | | 12 |
| (3) | | 16 |

Tools needed/ not included
Herramientas requeridas/ no incluidas
Outils requis/ non fournis

* Phillips Screwdriver
Desarmador de estrella (Phillips)
Tournevis Phillips

①

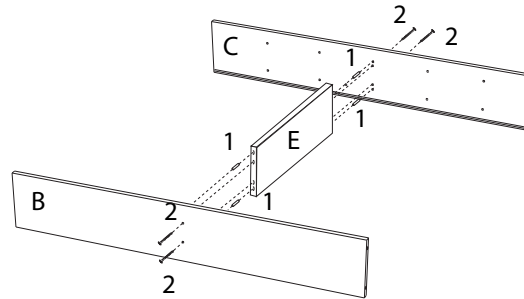

③

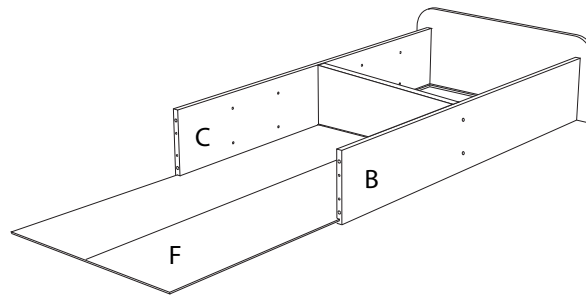

②

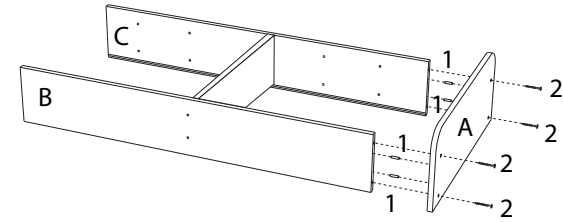

④

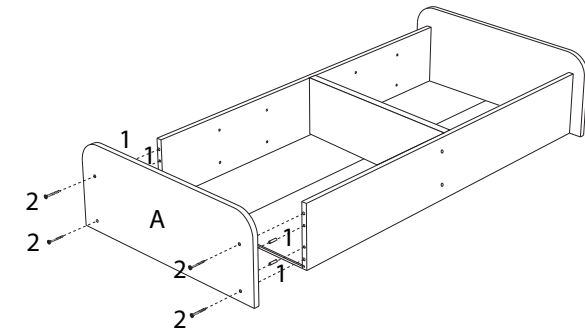

5

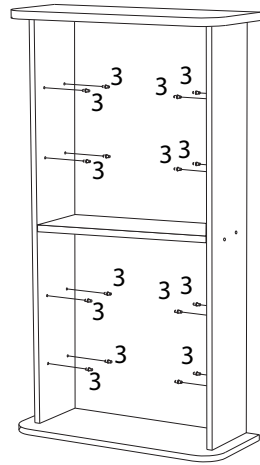

6

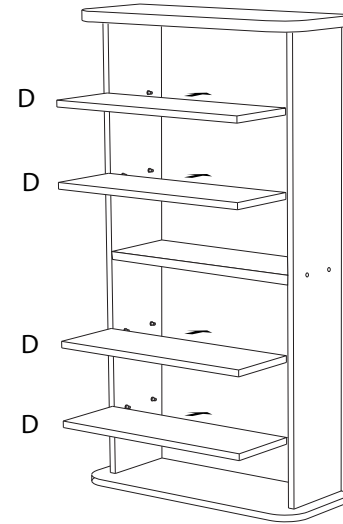

7

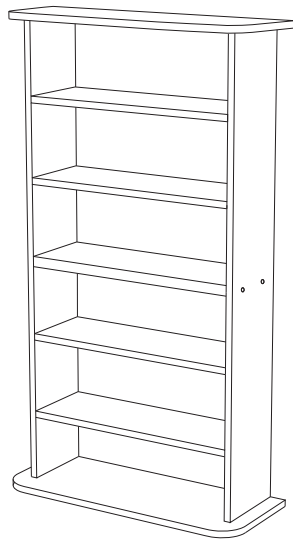

ATLANTIC

© 2009 Atlantic Inc. Santa Fe Springs, CA, U.S.A.
U.S. AND OTHER FOREIGN PATENTS PENDING
ALL RIGHTS RESERVED
www.atlantic-inc.com MADE IN CHINA

Patentes de los EUA y países extranjeros en trámite /
Brevets en cours pour les États-Unis et autres pays

Derechos Reservados / Tous droits réservés /

Hecho en China / Fabriqué en Chine /

R 1.0 090909 #37935622

