

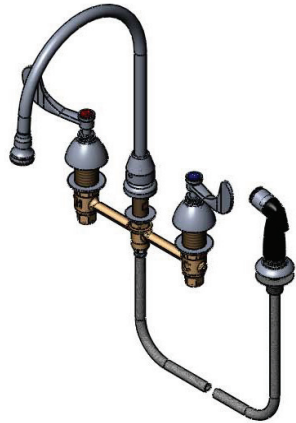

Easy Install™

**8" FIXED CENTER
CONCEALED
WIDESPREAD
B-2300, B-2800,
B-2900 SERIES**
Patent # 7,472,434

**Installation and
Maintenance
Instructions**



Limited One Year Warranty

T&S warrants to the original purchaser (other than for purposes of resale) that such product is free from defects in material and workmanship for a period of one (1) year from the date of purchase. During this one-year warranty period, if the product is found to be defective, T&S shall, at its option, repair and/or replace it. To obtain warranty service, products must be returned to.....

T&S Brass and Bronze Works, Inc.
Attn: Warranty Repair Department
2 Saddleback Cove
Travelers Rest, SC 29690

Shipping, freight, insurance, and other transportation charges of the product to T&S and the return of repaired or replaced product to the purchaser are the responsibility of the purchaser. Repair and/or replacement shall be made within a reasonable time after receipt by T&S of the returned product. This warranty does not cover items which have received secondary finishing or have been altered or modified after purchase, or for defects caused by physical abuse to or misuse of the product, or shipment of the products.

Any express warranty not provided herein, and any remedy for Breach of Contract which might arise, is hereby excluded and disclaimed. Any implied warranties of merchantability or fitness for a particular purpose are limited to one year in duration. Under no circumstance shall T&S be liable for loss of use or any special consequential costs, expenses or damages.

Some states do not allow limitations on how long an implied warranty lasts or the exclusion or limitation of incidental or consequential damages, so the above limitations or exclusions may not apply to you. Specific rights under this warranty and other rights vary from state to state.

P/N: 098-016898-45 Rev. 1
DATE: 11-08-10
DRAWN: TEH
CHECKED: JRM 11-12-10
APPROVED: JHB 11-12-10

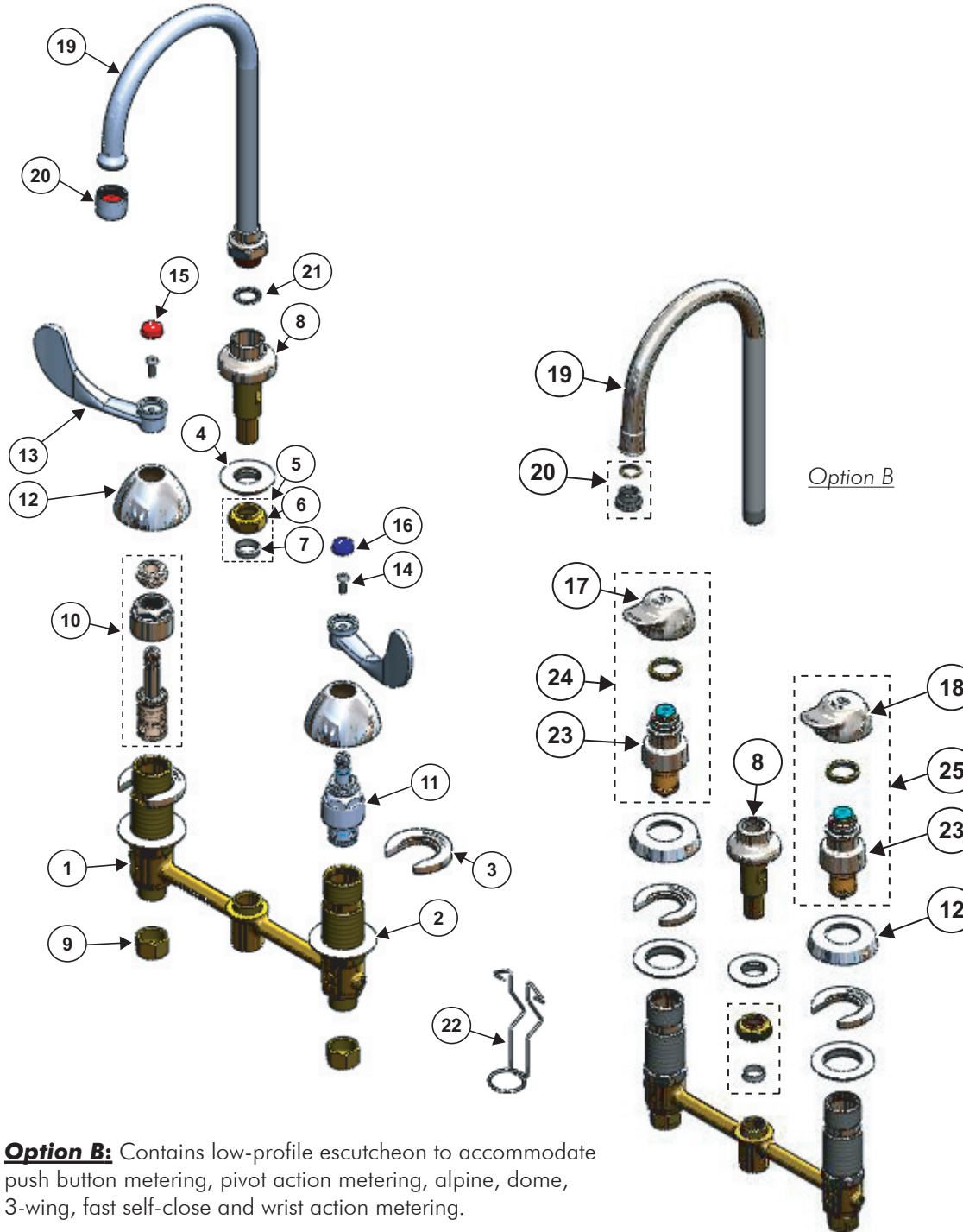

Option B: Contains low-profile escutcheon to accommodate push button metering, pivot action metering, alpine, dome, 3-wing, fast self-close and wrist action metering.

Parts List

1	Base Faucet Assembly	N/A	
2	Side Flange Nut	N/A	
3	C-Washer	016749-45	
4	Center Flange Nut	016742-45	
5	Compression & Nut Fitting	016745-45	
6	Compression Nut	N/A	
7	Compression Fitting	N/A	
8	Center Shank:		
	Center Shank, Swivel	016754-40	
	Center Shank, Rigid	016847-40	
9	Coupling Nut	000958-20	
12	Escutcheons:		
	Escutcheon, Bell	001257-40	
	Escutcheon, Metering	017292-45	Opt.B
22	Hanger	016777-45	
19	Rigid & Swivel Goosenecks	Inquire w/ T&S	
20	Aerators:		
	55/64"-27 Female Threads	B-0199-01	
	3/8" NPSM Male Threads	B-0199-02	
	13/16"-27 Male Threads	B-0199-03	
	Stream Regulator, Plain	B-LT	
	Stream Regulator w/ Screen	B-PT	
	Sidespray & Hose Assembly	001495-45	
21	Star Washer, Anti-Rotation	014200-45	

Cartridge Assemblies

10	Cartridge, Hot Eterna Teflon	016753-40	
	Cartridge, Hot Cerama	016767-25	
11	Cartridge, Cold Eterna Teflon	016752-40	
	Cartridge, Cold Cerama	016768-25	
	Wrist Action Metering	012449-40	Opt.B
	Hot Eterna Teflon - Short	017327-40	Opt.B
23	Push Button Metering	238A	Opt.B
24	Pivot Action Metering - Hot (shown)	238AH-PA	Opt.B
25	Pivot Action Metering - Cold (shown)	238AC-PA	Opt.B

Handle Assemblies

13	Handle, 4" Wrist Action (shown)	B-WH4	
	Handle, Lever	001638-45	
	Handle, 4-Arm	002521-45	
14	Screw, 4" Wrist Action (shown)	000925-45	
	Screw, Lever Handle	000922-45	
15	Index, Snap-In Red (Hot) (shown)	001194-45	
	Index, Lever Handle (Hot)	001661-45	
16	Index, Snap-In Blue (Cold) (shown)	001686-45	
	Index, Lever Handle (Cold)	001660-45	
17	Pivot Action Handle - Hot	PA-H	Opt.B
18	Pivot Action Handle - Cold	PA-C	Opt.B
	Cold Cap Assembly	014195-40	Opt.B
	Hot Cap Assembly	014194-40	Opt.B
	Lavatory Handle, 3-Wing - Cold	001784-40	Opt.B
	Lavatory Handle, 3-Wing - Hot	001783-40	Opt.B
	Fast Self-Closing Asm - Cold	002875-40	Opt.B
	Fast Self-Closing Asm - Hot	002876-40	Opt.B
	Cold Alpine Handle Assembly	076F-C	Opt.B
	Hot Alpine Handle Assembly	076F-H	Opt.B

Before starting the installation, be sure to flush supply lines and shut off water supply.

Step 1:

Take center shank out of body.

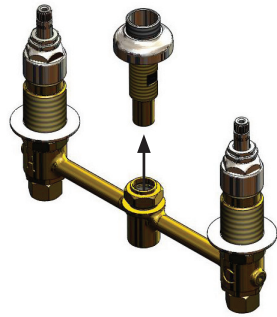

Step 4:

Option B: Screw metering escutcheons over c-washers. Tighten cartridges.

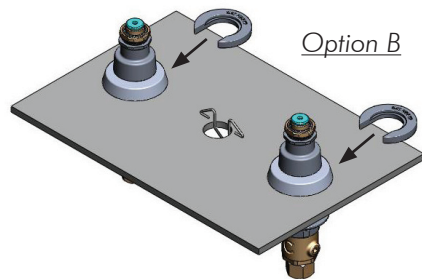

Step 6:

Remove nuts as shown. *Option B:* Remove retaining rings from cartridges. Place center body through center hole into main body. Tighten 3 flange nuts. Tighten compression nut to seal center body.

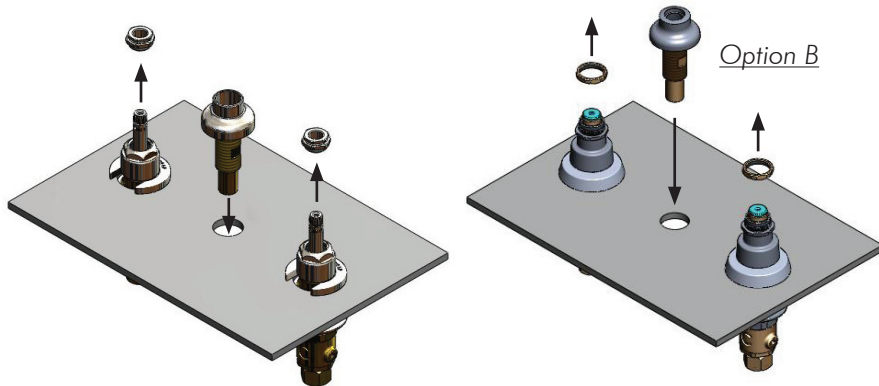

Step 2:

Place hanger on body. Add center flange nut to top of compression nut. *Option B:* Remove cartridges.

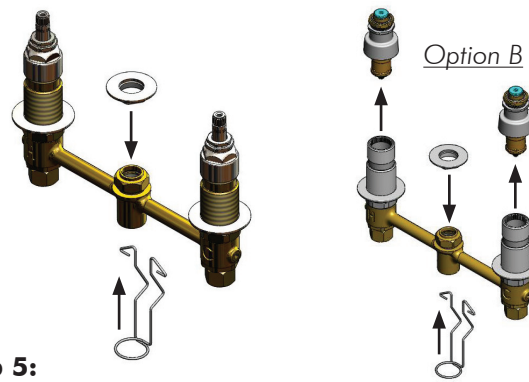

Step 5:

Squeeze hanger loops and allow hanger to drop through center hole.

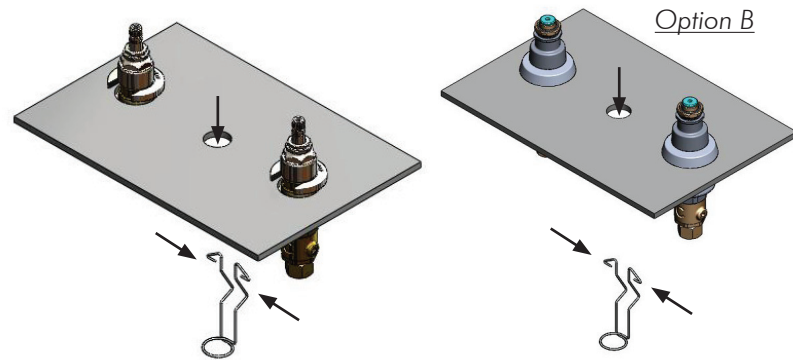

Step 7:

Add escutcheons, packing nuts, handles, spout and tighten. *Option B:* Add handles, retaining rings, spout and tighten. Turn on water supply and check for leaks.

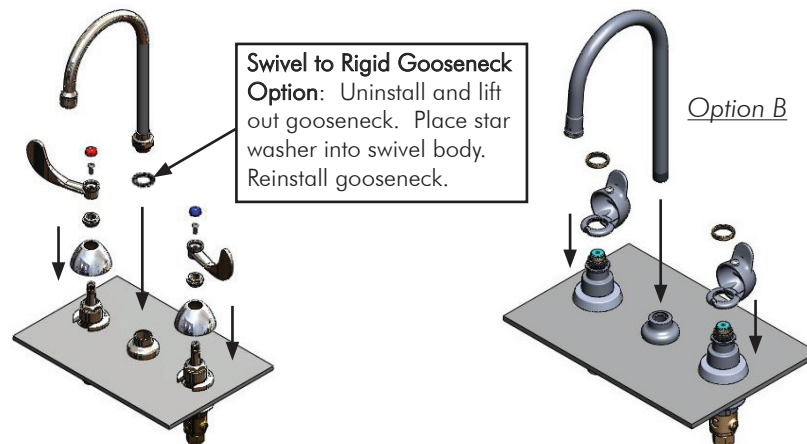

Step 3:

Insert body into deck holes until hanger snaps to top of deck. Place c-washers under bonnet nuts on side bodies.

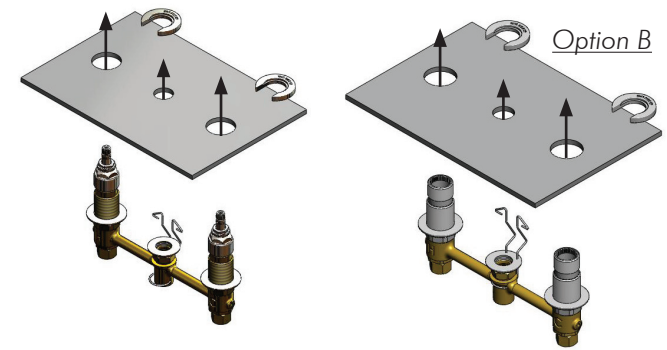

For models with sidespray:

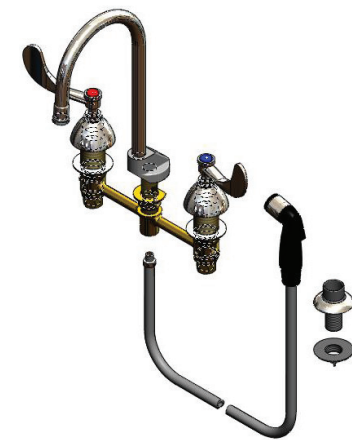

1. Tighten diverter to center body using flat head screwdriver.
2. Remove locknuts from hose guide, place it through existing hole in sink. Reinstall locknut on the hose guide. Tighten by hand.
3. Apply Teflon tape to threaded end of sidespray, insert through hose guide and attach threaded end of side spray to base of center body. Tighten with wrench.
4. Turn on water and check for leaks.