

ASSEMBLY INSTRUCTIONS

V-120-1 MISSION BUNK BED

Thank you for purchasing this quality product. Be sure to check all packing material carefully for small parts which may have come loose inside the carton during shipment. Separate, identify and count all parts and hardware. Compare with the parts list to be sure all parts are present.



**“DO NOT TIGHTEN SCREWS
UNTIL COMPLETELY ASSEMBLED”**

SIZE OF MATTRESS AND FOUNDATION (SUPPORT)

This bed is designed to use a twin mattress (37 ½” - 38 ½” x 74 - 75”) and bunkie board (37 ½ “ x 74”). The total thickness must not exceed 9 ” inches. Do not use mattress without the proper bunkie board or safe foundation.

Note: There must be at least 5” inches from top surface of mattress to top edge of guardrails.

REPLACEMENT PARTS.

Replacement parts, including additional guardrails, may be obtained from place of purchase or original distribution.

TO OBTAIN PARTS, PLEASE CONTACT: DONCO TRADING COMPANY - FORT WORTH, TEXAS

SAFETY WARNINGS!

- 1- Follow the information on the warning label appearing on the upper bunk end structure and on the carton. Do not remove warning label from bed.
- 2- Always use the recommended size mattress or mattress support, or both, to help prevent the likelihood of entrapment or falls.
- 3- Surface of mattress must be at least 5 inches below the upper edge of guardrails.
- 4- Do not allow children under 6 years of age to use the upper bunk.
- 5- Prohibit more than one person on upper bunk.
- 6- Periodically check and ensure that the guardrail, ladder and other components are in their proper position, free from damage, and that all connectors are tight.
- 7- Do not allow horseplay on or under the bed and prohibit jumping on the bed.
- 8- Always use the ladder for entering and leaving the upper bunk.
- 9- Do not use substitute parts. Contact manufacturer or dealer for replacement parts.
- 10- Use of a night light may provide added safety precaution for a child using the upper bunk.
- 11- If the bunk bed will be placed next to a wall, the guardrail that runs the full length of the bed should be placed against the wall to prevent entrapment between the bed and the wall.
- 12- Always use guard rails on both long sides of the upper bunk.
- 13- The use of water or sleep flotation mattresses is prohibited.
- 14- Keep these instructions for future reference.
- 15- Strangulation Hazard - Never attach or hang items to any part of the bunk bed that are not designed for use with the bed: for example, but not limited to, hooks, belts, and jump ropes, etc.



IMPORTANT: PLEASE READ INSTRUCTIONS BEFORE STARTING THE ASSEMBLY

ASSEMBLY INSTRUCTIONS

V-120-1 MISSION BUNK BED



Thank you for purchasing this quality product. Be sure to check all packing material carefully for small parts which may have come loose inside the carton during shipment. Separate, identify and count all parts and hardware.

Compare with the parts list to be sure all parts are present.

“DO NOT TIGHTEN SCREWS UNTIL COMPLETELY ASSEMBLED”

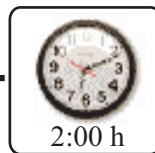
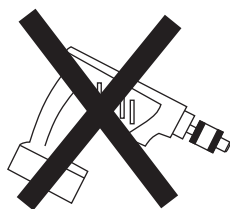

Tools Required

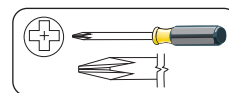

(Not included)

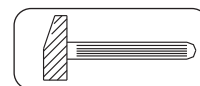

(Hammer)

!
* Use of power tool to assemble this product will invalidate any claim and damage this product making unsafe !!!
* Please assemble on a clean soft surface to avoid damage.

**IMPORTANT:
PLEASE READ INSTRUCTION BEFORE STARTING THE ASSEMBLY**

Part List - V-120-1 MISSION BUNK BED

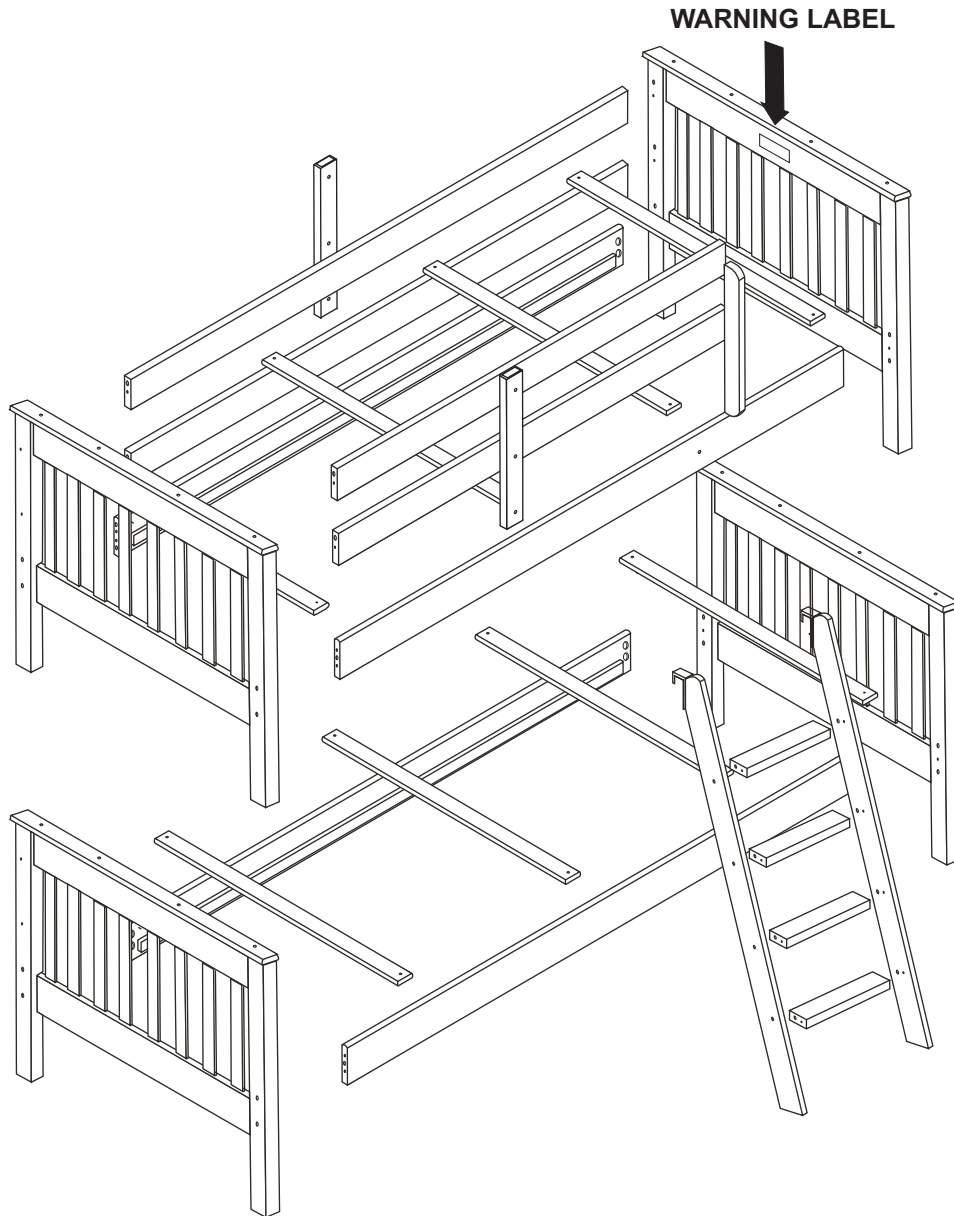

Identifying the Hardware/part list- Identify the hardware using the illustrations below.

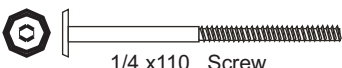
A  Qty **16**
1/4 x 110 Screw

B  Qty **16**
1/4\"

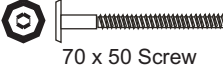
C  Qty **11**
70 x 50 Screw

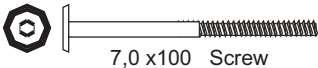
D  Qty **06**
7,0 x 100 Screw

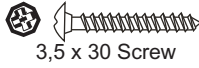
E  Qty **38**
3,5 x 30 Screw

F  Qty **01**
Hex Screwdriver

G  Qty **04**
10 x 110 Wood Dowel

H  Qty **06**
3,5 x 16 Screw

I  Qty **26**
10 x 40 Wood Dowel

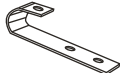
J  Qty **02**

01

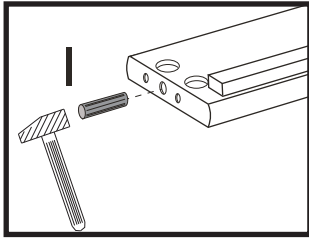

ATTENTION!!

HOLE

SIDERAIL FOR UP BED-LADDER SIDE

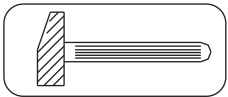
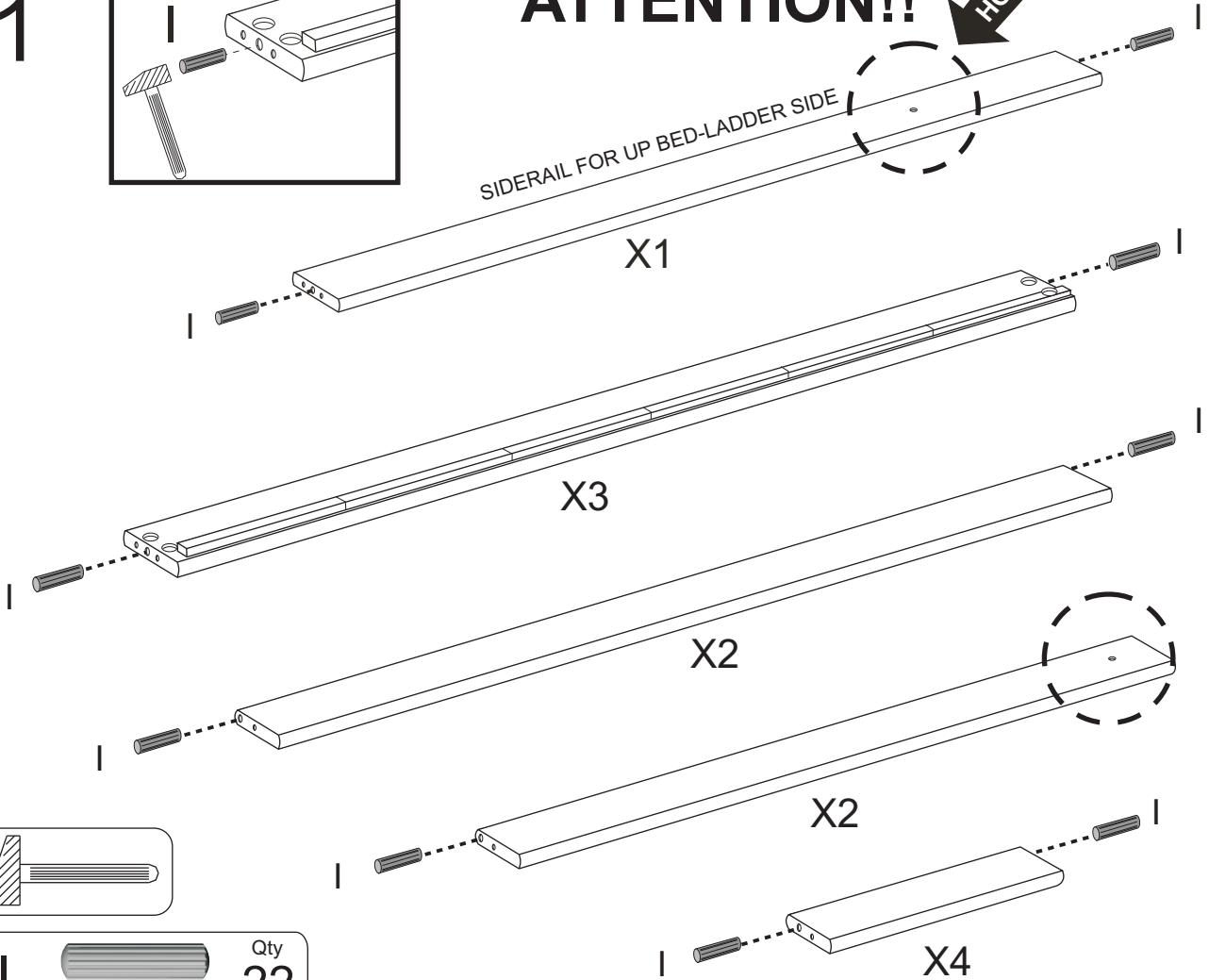

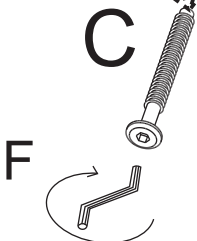
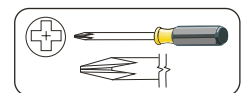
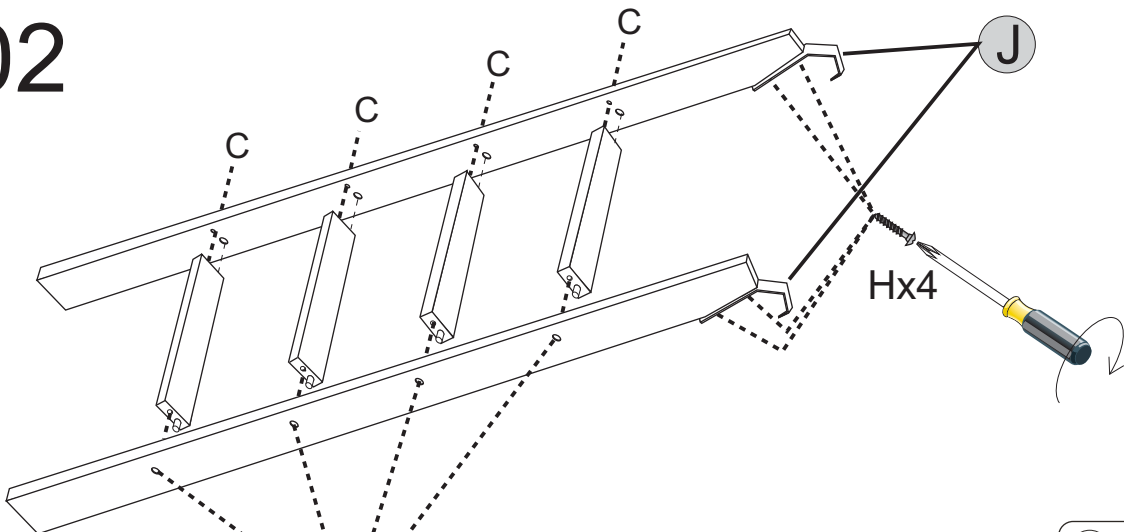

I 10 x 40 Wood Dowel Qty 22

02



F  Qty 01

C  Qty 08

H  Qty 04

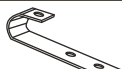
J  Qty 02

03

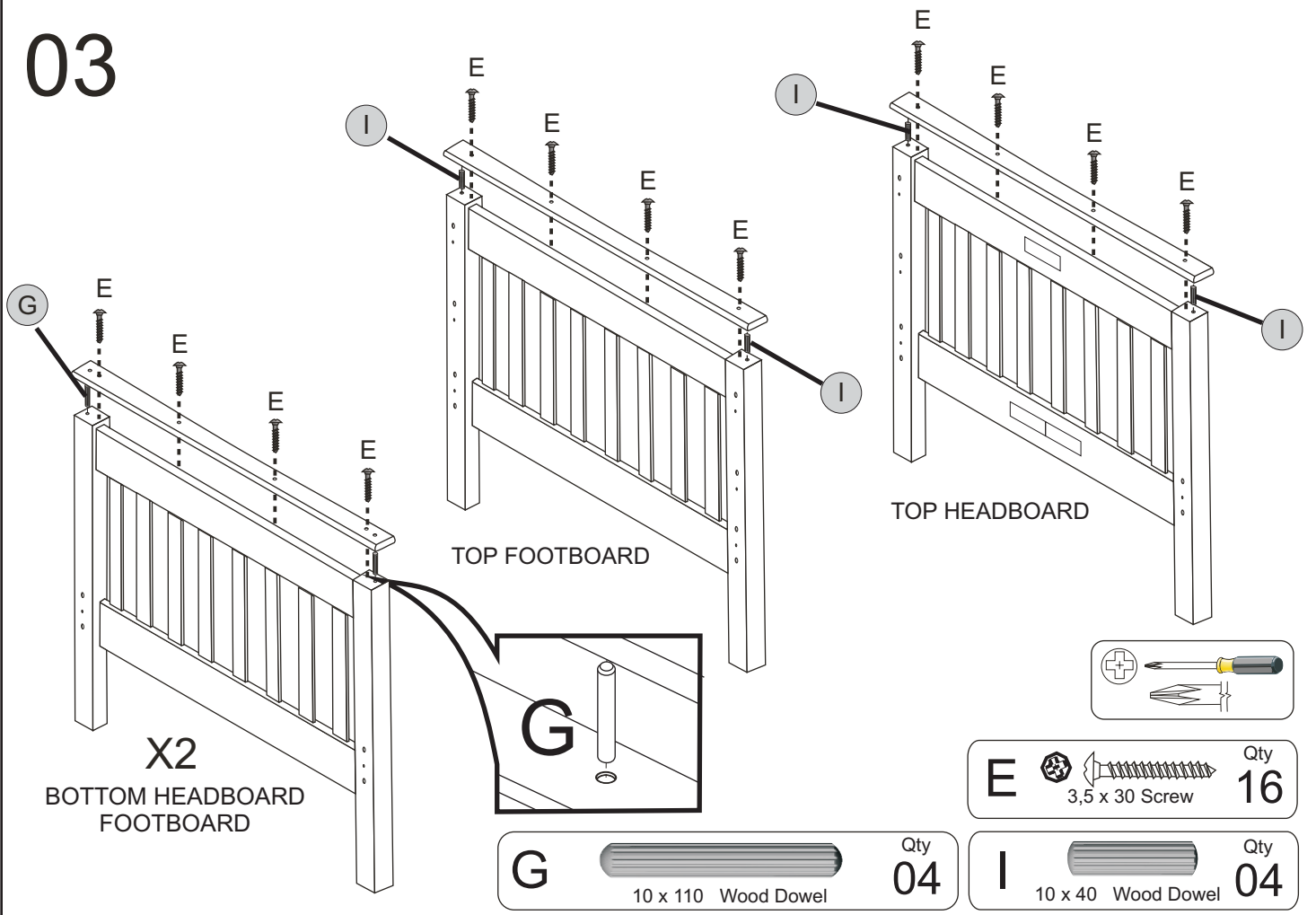

04

BOTTOM BED

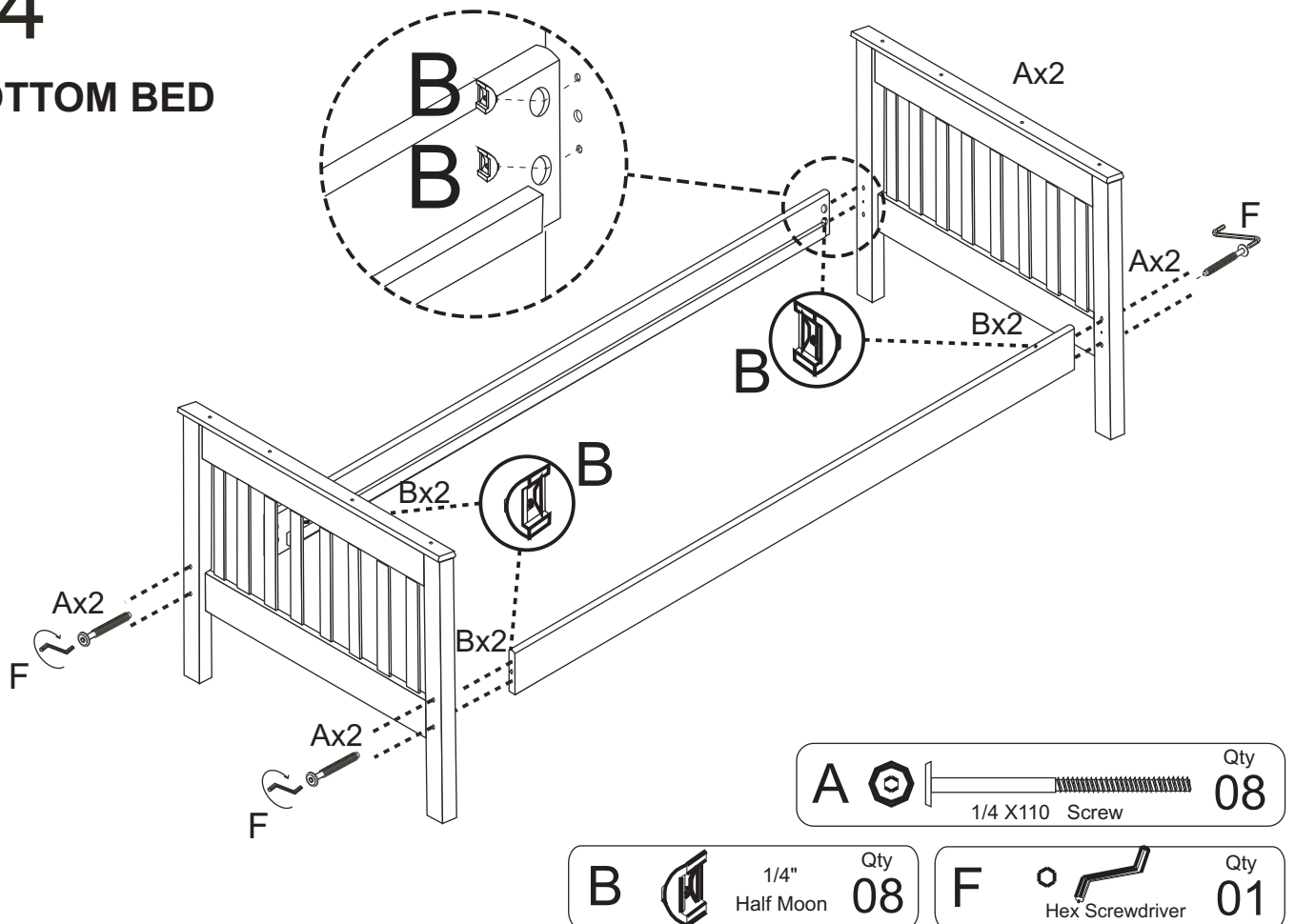

05

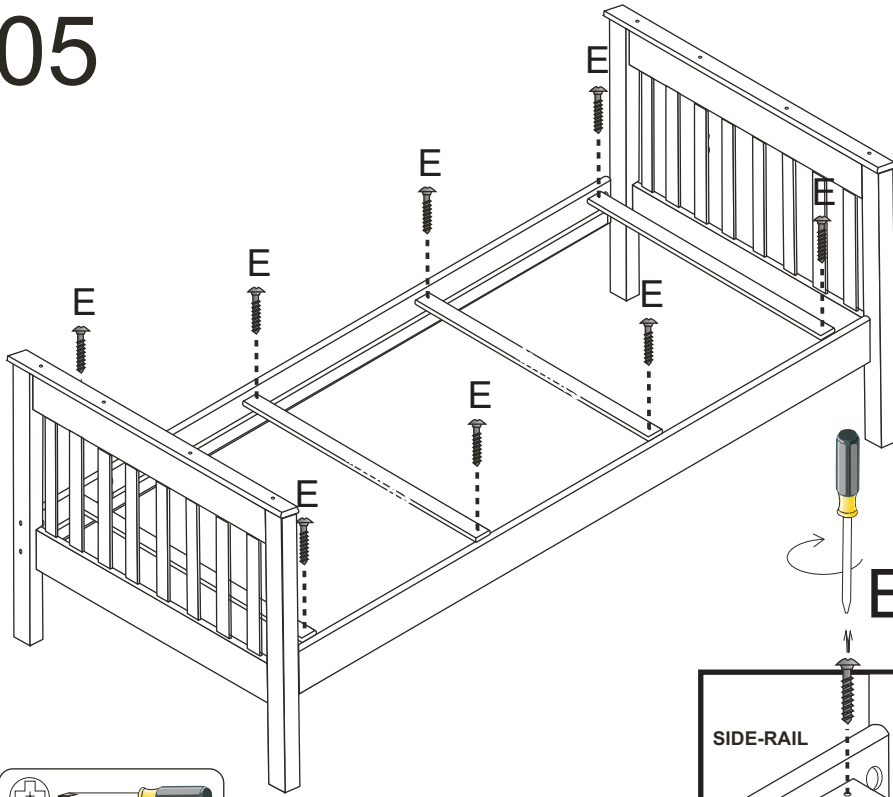

!
Please refer to the diagram on the left for correct placement of the cross-slats

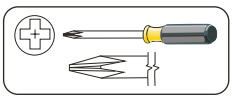
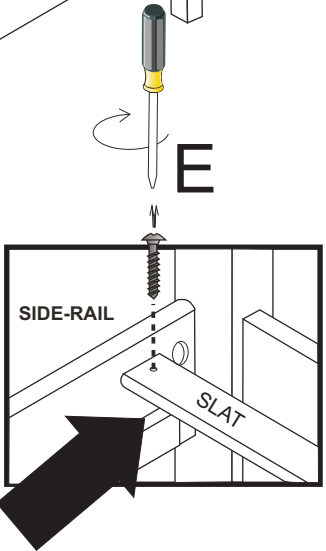
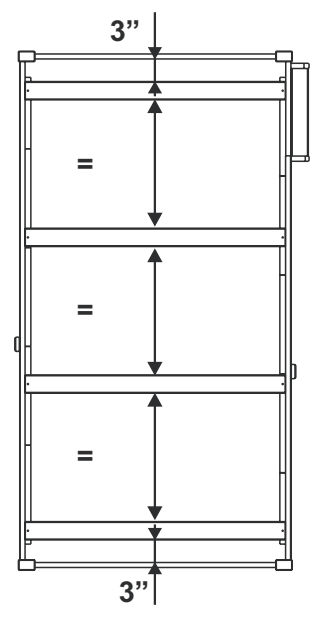

E  Qty **08**
3,5 x 30 Screw

06

TOP BED

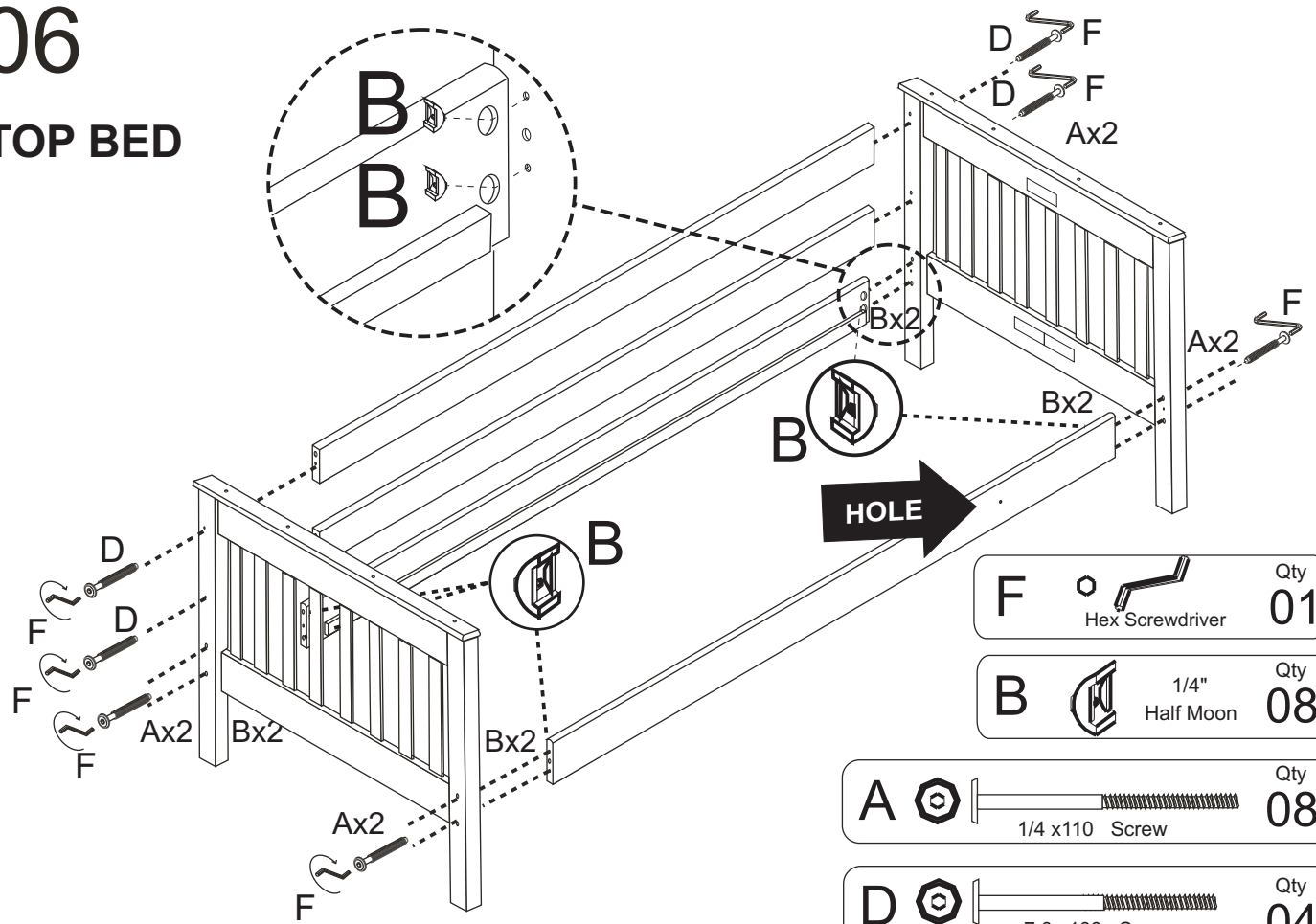
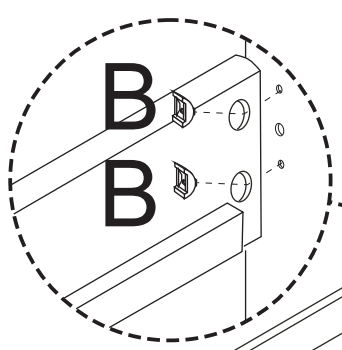

F  Qty **01**
Hex Screwdriver

B  Qty **08**
1/4" Half Moon

A  Qty **08**
1/4 x 110 Screw

D  Qty **04**
7,0 x 100 Screw

07

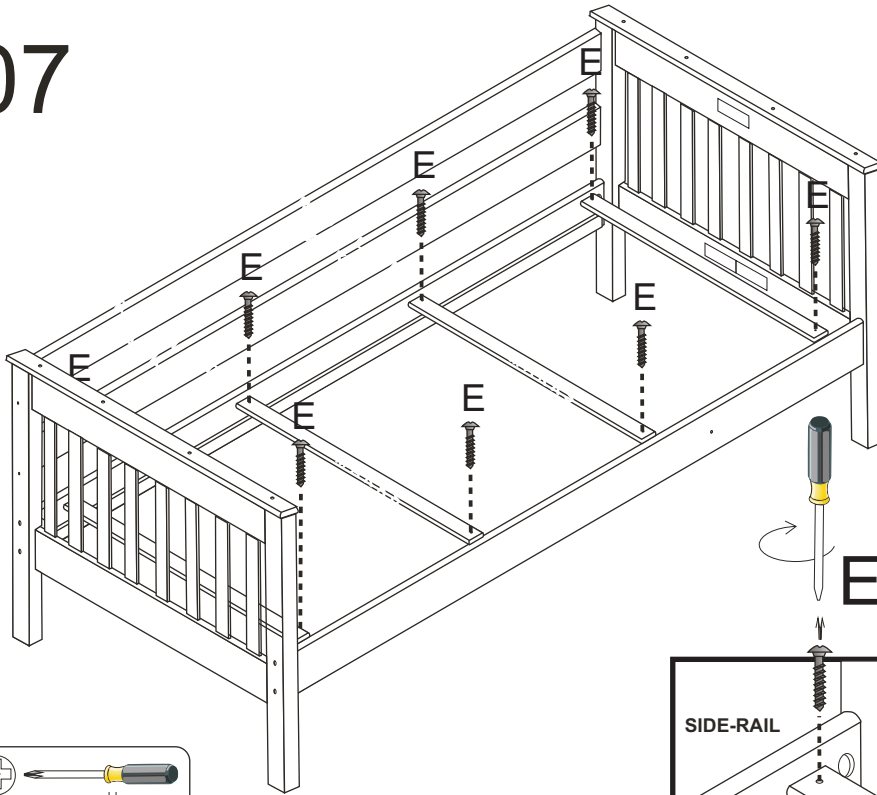

 Please refer to the diagram on the left for correct placement of the cross-slats

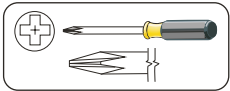
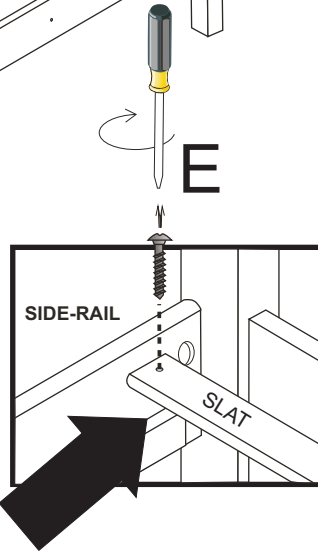
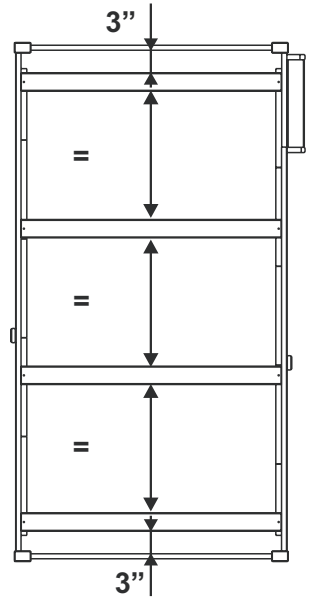

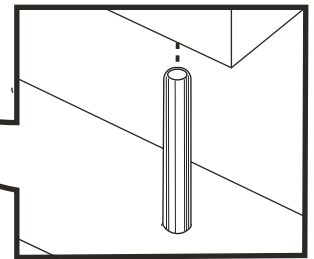
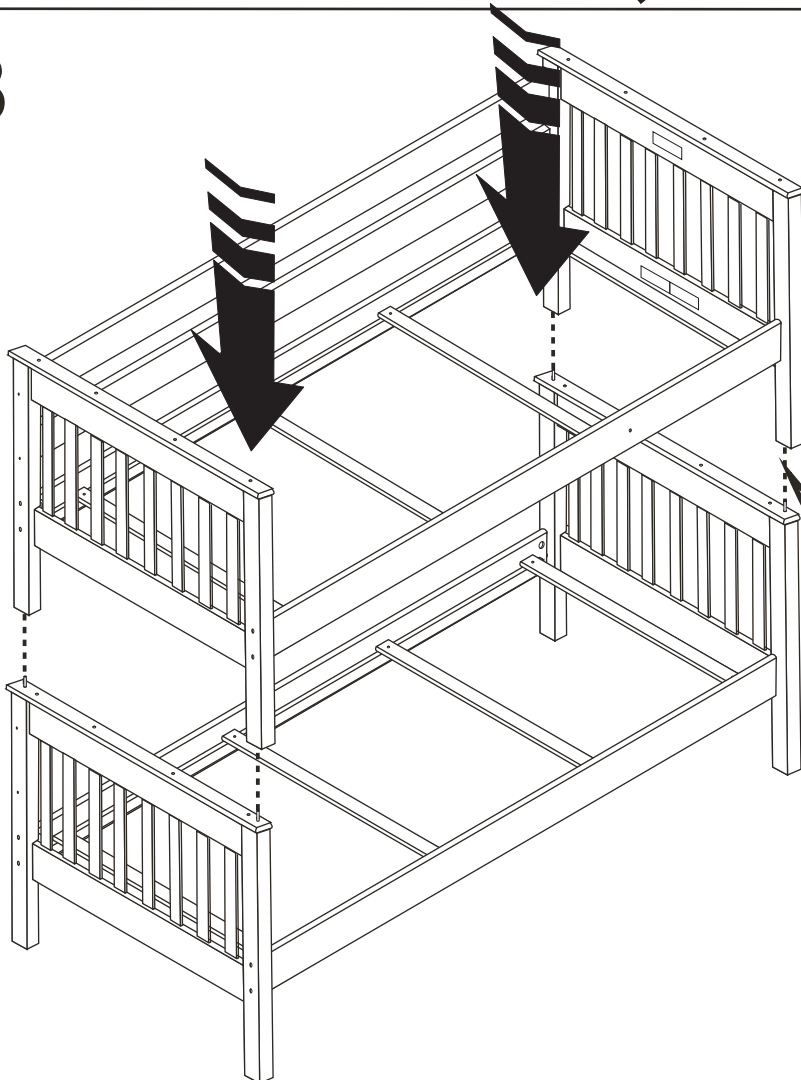

E  Qty **08**
3,5 x 30 Screw

08

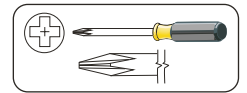
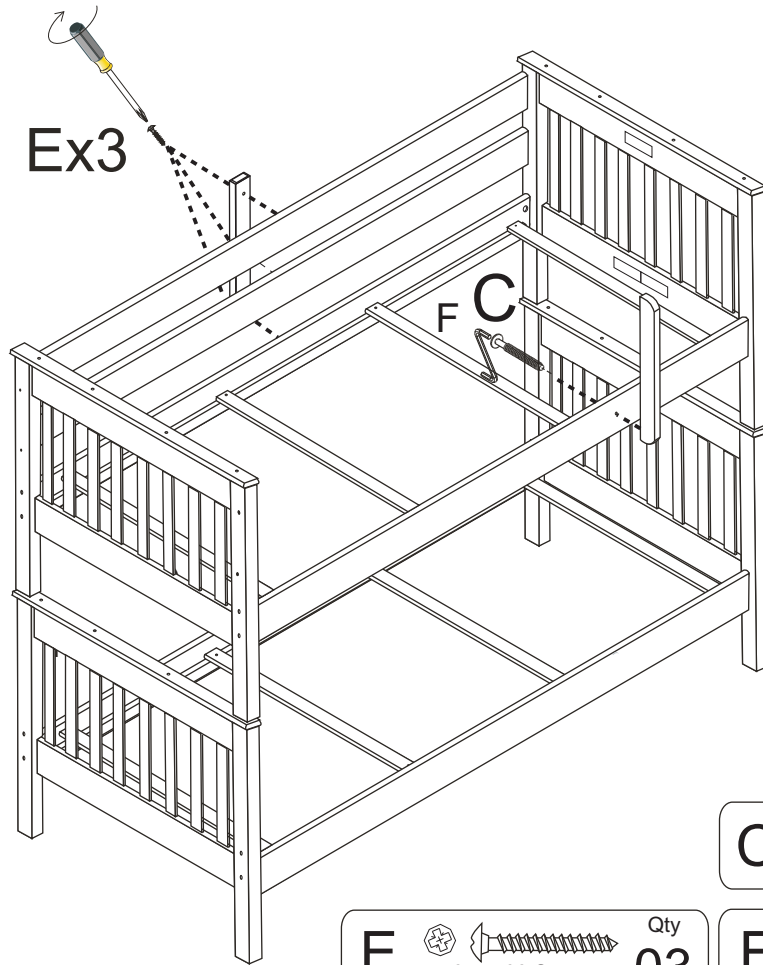

09





C  Qty **01**
7,0 x 50 Screw

E  Qty **03**
3,5 x 30 Screw

F  Qty **01**
Hex Screwdriver

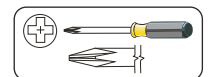
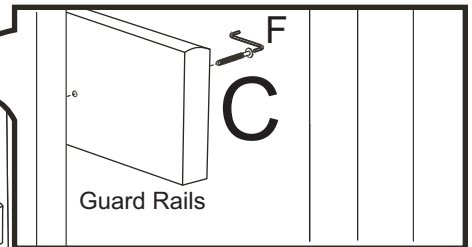
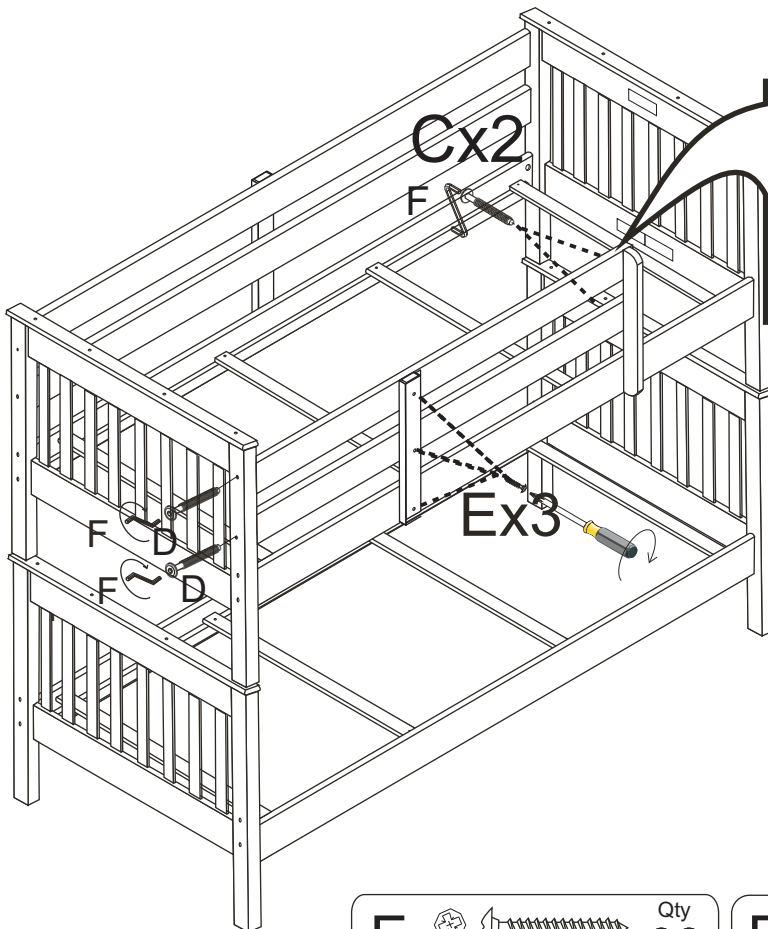
10



C  Qty **02**
7,0 x 50 Screw

F  Qty **01**
Hex Screwdriver

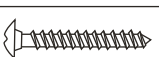
E  Qty **03**
3,5 x 30 Screw

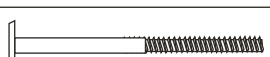
D  Qty **02**
7,0 x 100 Screw

11

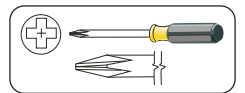
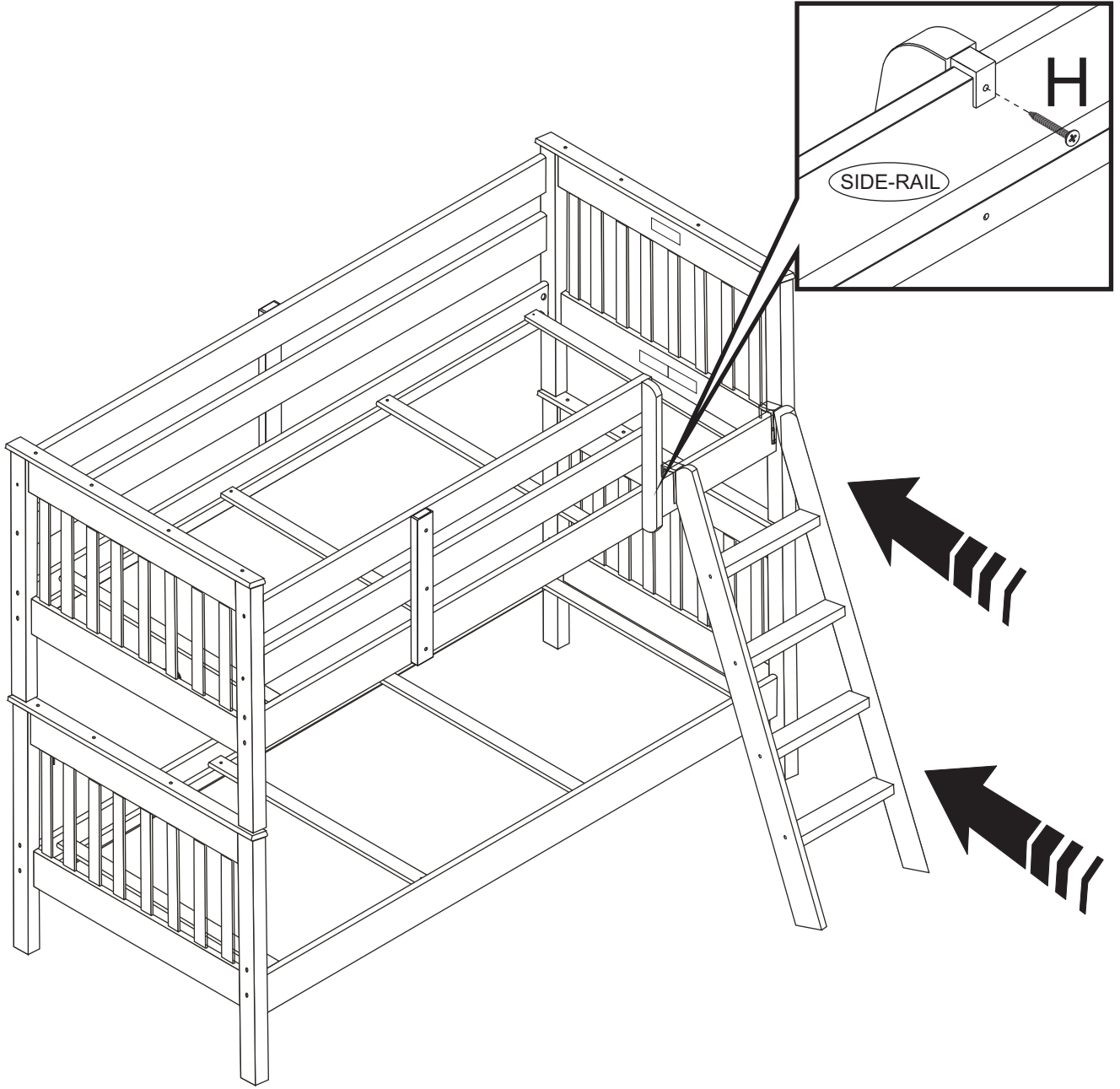

H  3,5 x 16 Screw Qty **02**