

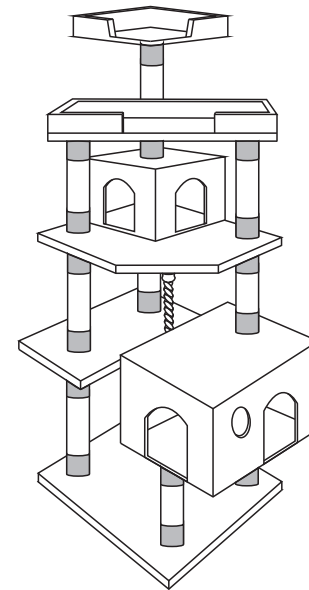

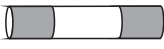

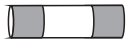



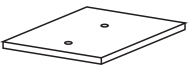

PLEASE NOTE: IT WILL BE BEST TO SORT AND GROUP ALL THE SAME SIZE POSTS ACCORDING TO THEIR LENGTH AND DIFFERENT PARTS TOGETHER PRIOR TO INSTALLATION

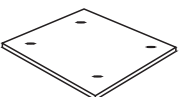

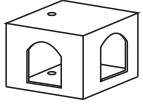
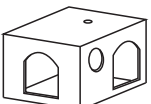
F-2023

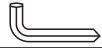

<p>A</p> <p>∅3"*15.7"</p>  <p>7pcs</p>	<p>B</p> <p>∅3"*10.2"</p>  <p>3pcs</p>	<p>C</p> <p>L16"</p>  <p>1pc</p>
<p>D</p> <p>21"*11.5"</p>  <p>1pc</p>	<p>E</p> <p>12.5"*12.5"*H2"</p>  <p>1pc</p>	<p>F</p> <p>24.5"*12"*H2"</p>  <p>1pc</p>
<p>G</p> <p>23"*21"</p> 	<p>H</p> <p>23"*21"</p>  <p>1pc</p>	<p>I</p> <p>12"*12"*H9.5"</p>  <p>1pc</p>
<p>J</p> <p>18"*12.5"*H11.5"</p>  <p>1pc</p>		

		1pc
 <p>W1</p>	∅ 0.31"*1.57"	11pcs
 <p>W2</p>	∅ 0.31"*2.36"	1pc
 <p>W3</p>	∅ 0.31"*3.1"	4pcs

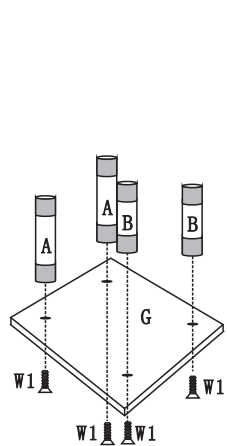

step 1

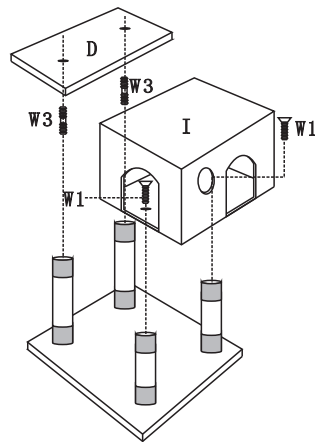

step 2

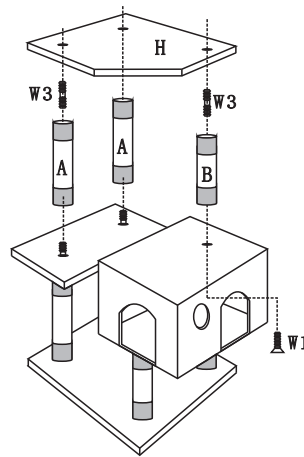

step 3

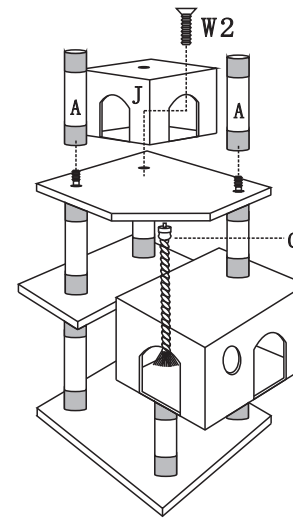

step 4

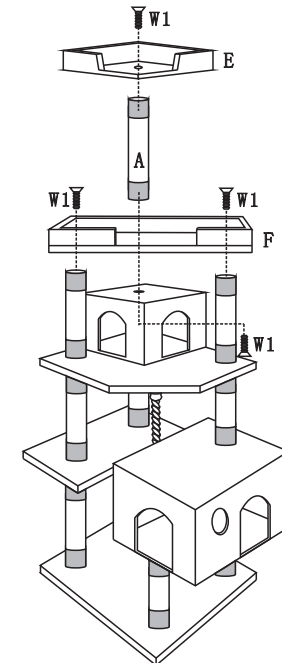

step 5