

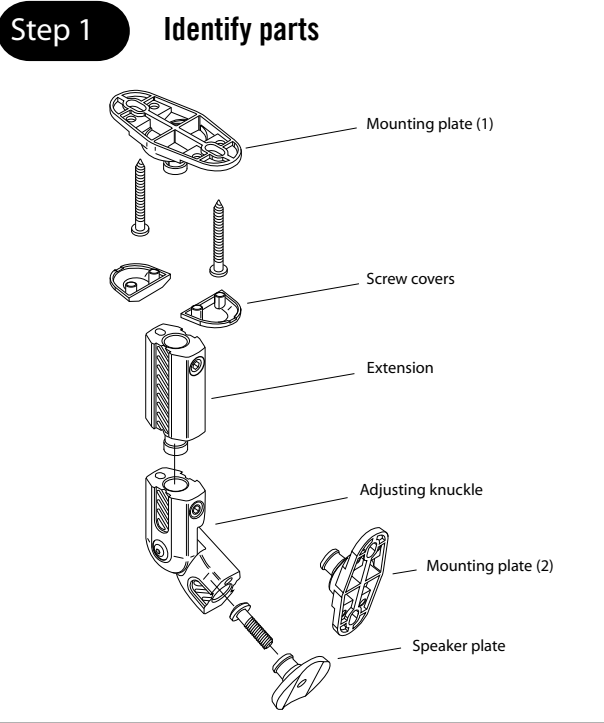

AB2/AB2 HTS INSTALLATION INSTRUCTIONS

These fasteners and tools are provided



	AB2	HTS		AB2	HTS	
	(1)	(5)	M4 X 12mm Phillips pan head machine screw		(2)	(10)
	(1)	(5)	M5 X 12mm Phillips pan head machine screw		(1)	(5)
	(2)	(10)	#12 X 3/4" Phillips pan head self-tapping screw		(1)	(5)
	(2)	(10)	#12 X 1-3/4" Phillips pan head self-tapping screw		(1)	(5)
	(1)	(5)	5/32" Hex key		(1)	(2)

Additional installation tools

Phillips Head Screw Driver

Pencil

Electric Drill

Drill Bits: 1/8" drill bit for drywall

5/16" masonry bit for cement wall applications

Step 2 Decide on location

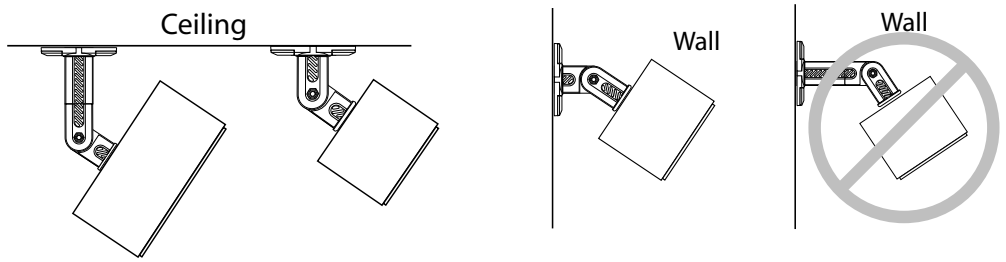

Step 3 Installation of the wall plate

Mounting to drywall.

1. Use the wall plate as a template and mark the screw hole locations onto the surface using a pencil.
2. Drill into the drywall with a 1/4" drill bit. Insert the anchors into the hole as shown in fig. 3.
3. Secure with the #12 x 1-3/4" screws, see fig. 4.

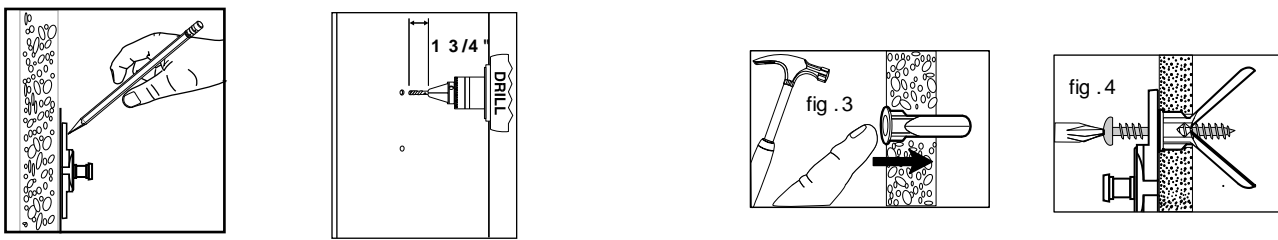

Mounting to solid concrete or cinder block.

1. Drill into the surface with a 3/16" masonry drill bit 1-3/4" deep and insert the anchors into the holes as shown in Fig. 3
2. Secure wall plate with the #12 x 1-3/4" , see fig. 4.

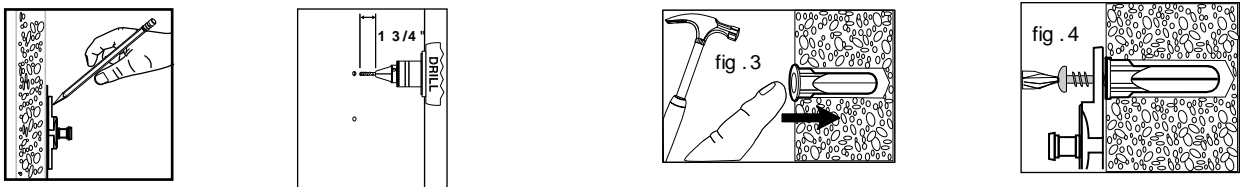

Step 3 Installation of wall plate (continued)

Mounting to solid wood or wood studs.

Drill a pilot hole into center of each location using 3/32" drill bit (provided). Drill 1-1/4" into stud. Attach the plate with two #12 x 1-3/4" wood screws.

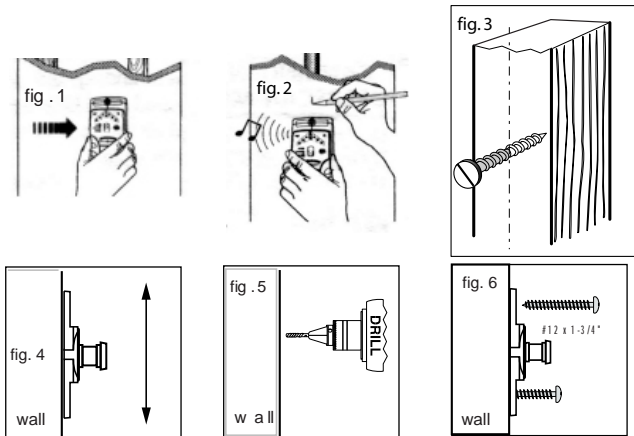

Step 4 Installation of speaker plate onto speaker

1. Bose® speakers with 4mm or 5mm inserts.



2. Speakers with single factory installed threaded insert.

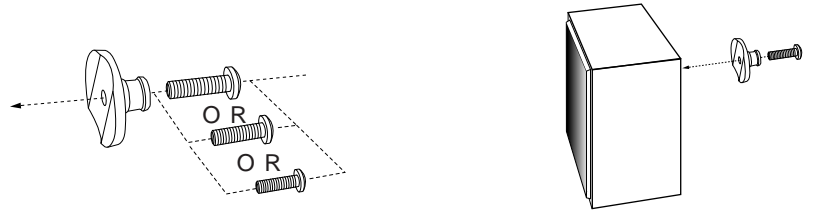

3. Speakers with 2 installed 1/4"-20 or 6mm x 15mm threaded inserts.

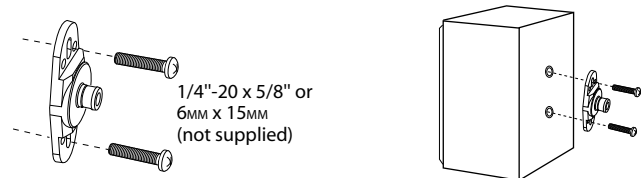

4. Speakers with a single keyhole in back.
Insert into keyhole and slide upward then tighten.

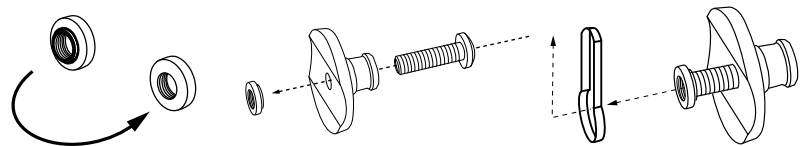

5. Speakers without mounting holes - wood cabinet only.

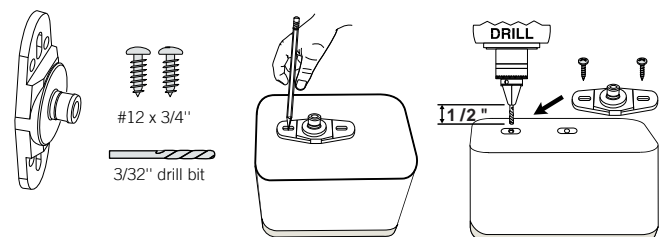

Step 5 Installation of adjusting knuckle and extension.

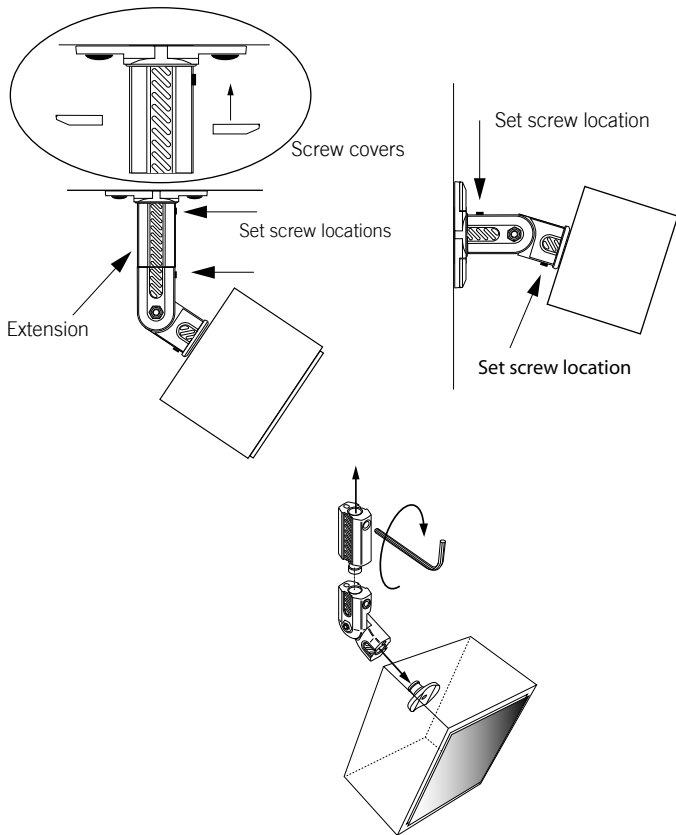

OMNI MOUNT

OmniMount Systems, Inc.
The Pointe at South Mountain
8201 South 48th Street
Phoenix, Arizona 85044-5355
Toll free 1-800-MOUNT-IT
(480) 829-8000
Fax: (480)756-9000
email: info@omnimount.com

100% Replacement Warranty

Audio Basics products are engineered and manufactured to the highest standards. In the event that there are defects in materials, workmanship, or missing parts, OmniMount Systems will, at its discretion, repair or replace your Audio Basics product. Claims that are submitted must include either the sales slip or proof of purchase.
If OmniMount products are used for purposes other than their original intent, OmniMount Systems, its distributors and retailers shall not be held responsible or liable for injuries or property damage, direct, indirect or consequential, which may arise from the inability to use this product safely, properly, and in the manner for which it has been designed and manufactured.
This warranty does not apply to products which have been lost, damaged by misuse, abuse or accident, altered or repaired in any way other than specified by OmniMount Systems, Inc.
This warranty is non-transferable.
For installation assistance please call our toll free help line at 1-800-MOUNT-IT

Copyright 2004 OmniMount Systems, Inc. All rights reserved. OmniMount products are covered by patents issued and/or pending. "OmniMount" is a registered trademark of OmniMount Systems, Inc. "Audio Basics" is a trademark of OmniMount Systems, Inc.
AB-2 revision 2, 1/04 Part #1000254.