



Langlade® Smart Divide®

Top-mount Kitchen Sink
K-6626-5

Features

- 33-inch minimum base cabinet width.
- KOHLER cast iron.
- Acid-resistant enamel finish.
- Double (equal) compartment.
- Top-mount.
- Smart Divide™ lowered divider.
- Three faucet holes with one accessory hole to the right and one accessory hole to the left.
- 33" (838 mm) x 22" (559 mm).

Recommended Accessories

K-9000 P-Trap

Optional Accessories

K-6061 Sink Rack
K-6066 Sink Rack
K-6545 Sponge Caddy
K-8801 Sink Strainer



Codes/Standards











ASME A112.19.1/CSA B45.2

KOHLER® Enameled Cast Iron Kitchen Sink - Lifetime Limited Warranty

See website for detailed warranty information.

Available Color/Finishes

Color tiles intended for reference only.

| Color | Code | Description |
|--|------|--------------|
|  | 0 | White |
|  | FF | Sea Salt™ |
|  | 96 | Biscuit |
|  | 47 | Almond |
|  | FD | Cane Sugar™ |
|  | 95 | Ice™ Grey |
|  | G9 | Sandbar |
|  | K4 | Cashmere |
|  | 20 | Suede |
|  | KA | Black 'n Tan |
|  | 7 | Black Black™ |

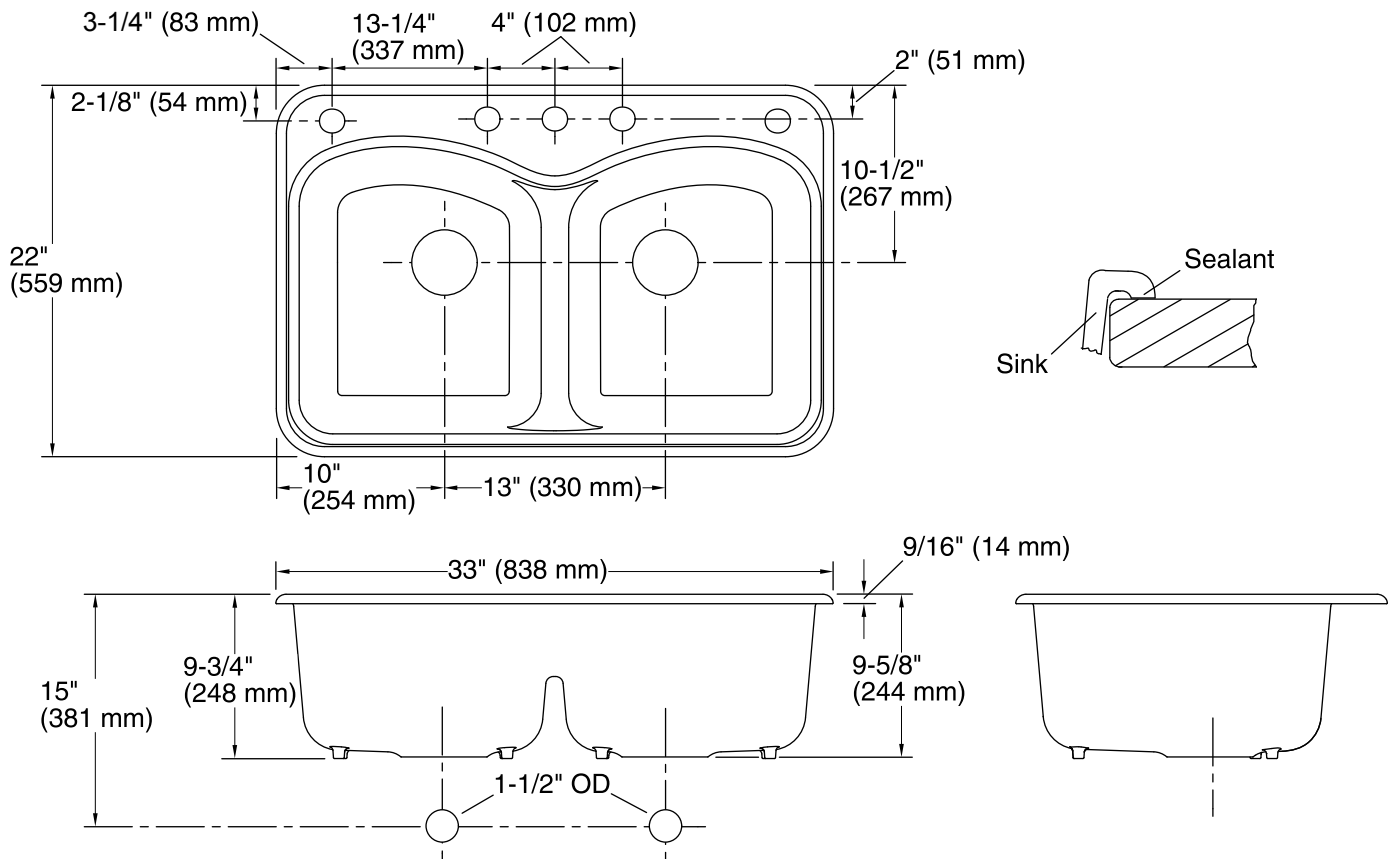

Technical Information

All product dimensions are nominal.

Bowl configuration: Double equal

Installation: Top-mount

Bowl area (Left) Length: 15" (381 mm)
Width: 18-3/8" (467 mm)
Bowl depth: 9" (229 mm)

Bowl area (Right) Length: 15" (381 mm)
Width: 18-3/8" (467 mm)
Bowl depth: 9" (229 mm)

Number of deck holes: 5

Faucet hole(s): 1-3/8" (35 mm)

Drain hole: 3-5/8" (92 mm)

Template: Top-mount, 1043753-7, required, included

Notes

Install this product according to the installation guide.