

Features

- With overflow.
- 8" (203 mm) centers.
- 20-1/8" (511 cm) x 16-1/2" (419 cm)

Material

- Vitreous china.

Installation

- Drop-in

Recommended Accessories

- K-7107 Decorative drain
- K-7108 Decorative Drain
- K-7129 Drain
- K-9018 P-Trap



ADA CSA B651

Codes/Standards











ASME A112.19.2/CSA B45.1
ADA
ICC/ANSI A117.1
CSA B651

KOHLER® One-Year Limited Warranty

See website for detailed warranty information.

Available Color/Finishes

Color tiles intended for reference only.

Color	Code	Description
	0	White
	96	Biscuit
	47	Almond
	NY	Dune
	95	Ice™ Grey
	G9	Sandbar
	33	Mexican Sand™
	K4	Cashmere
	58	Thunder™ Grey
	7	Black Black™

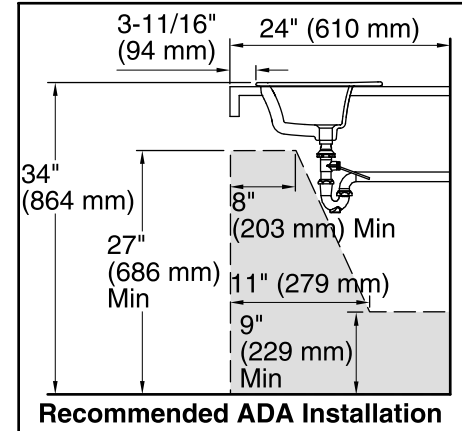
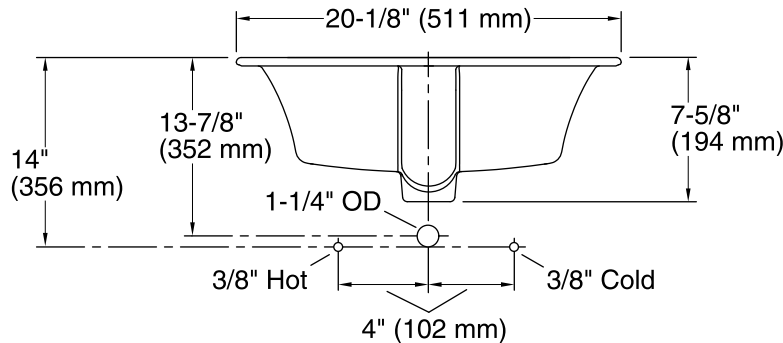
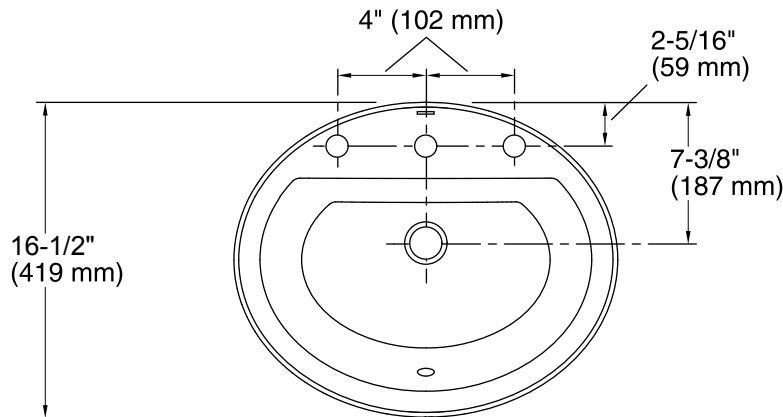

Technical Information

All product dimensions are nominal.

Installation:	Drop-In
Bowl area	Length: 17-3/8" (441 mm) Width: 11-1/8" (283 mm) Water depth: 5-5/8" (143 mm)
Number of deck holes:	3
Faucet hole(s):	1-3/8" (35 mm)
Drain hole:	7/8" (22 mm)
Template:	Drop-in, 1155261-7, required, included

Notes

Install this product according to the installation guide.

Spout must be 5" (12.7 cm) long (min) for adequate clearance into the lavatory when installed with the centerline as shown.

Spout must be tall enough to clear 3" (7.6 cm) rim height and provide a 1" (2.5 cm) air gap per ASME A112.1.1.

NOTICE: Countertop manufacturer or cutter must use the cut-out template provided with the product, or a current one provided by Kohler Co. (call 1-800-4-KOHLER). Kohler Co. is not responsible for cutout errors when the incorrect cut-out template is used.

ADA, CSA B651 compliant when installed to the specific requirements of these regulations.