

Features

- Vitreous china
- Two-piece toilet
- Comfort Height® Elongated bowl
- Dual Flush flushing system
- Includes top-mount dual flush trip lever
- 1.6 gpf (6.0 lpf) or 1.0 gpf (3.8 lpf)
- Fully skirted trapway
- 12" (305 mm) rough-in
- Supply line included
- 4-1/2" (114 mm) x 5-3/4" (146 mm) water area
- 28-5/8" (727 mm) x 14-3/16" (360 mm) x 32-1/2" (826 mm)
- Floor mount / Floor outlet

Recommended Accessories

- K-4650 Toilet Seat
- K-4774 Toilet Seat
- K-7659 Angle Stop
- K-7668 Straight Stop

Components

Product includes:

- K-4353 Toilet Bowl
- K-4441 Toilet Tank

Additional included component/s: Tank cover, Dual flush push buttons, Installation kit, Installation template, Tank accessory pack, and Toilet seat.



Codes/Standards







- ASME A112.19.2/CSA B45.1
- ASME A112.19.14
- DOE - Energy Policy Act 1992
- EPA WaterSense®

KOHLER® One-Year Limited Warranty

See website for detailed warranty information.

Available Color/Finishes

Color tiles intended for reference only.

Color	Code	Description
	0	White
	96	Biscuit
	47	Almond
	NY	Dune
	95	Ice™ Grey
	7	Black Black™

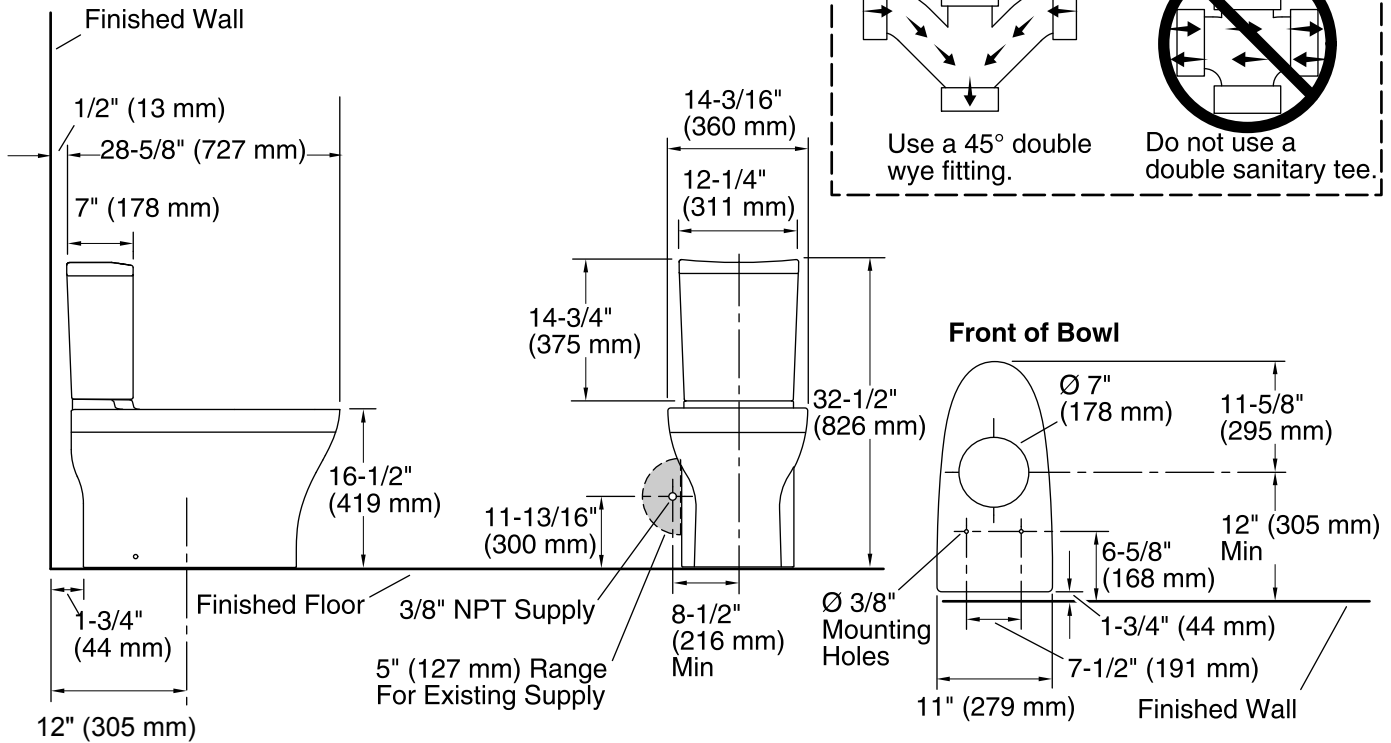

Technical Information

All product dimensions are nominal.

Toilet type:	Two-piece
Bowl shape:	Elongated front
Trap passageway:	2" (51 mm)
Water Consumption	
Full:	1.6 gpf (6 lpf)
Reduced:	1 gpf (3.8 lpf)
Water surface size:	4-1/2" x 5-3/4" (114 mm x 146 mm)
Rim to water surface:	8-1/2" (216 mm)
Rough-in:	12" (305 mm)
Seat-mounting holes:	5-1/2" (140 mm)

Notes

Install this product according to the installation guide.

IMPORTANT! The rough-in must be 12" (305 mm) or more from the base of the wall or baseboard. Install or relocate the supply and outlet as necessary to conform to rough-in dimensions.

If this toilet is installed in new construction, install a new supply stop following the dimensions in the diagram.

In installations with the supply stop installed, the existing supply stop may need to be relocated if it is less than 8-1/2" (216 mm) from the centerline of the toilet. Dry fit the toilet to confirm if the supply stop needs to be relocated.

The supplied hose will extend roughly 6" (152 mm) from the toilet. If the supplied hose does not reach the supply stop, a longer supply hose may be used.

For back-to-back toilet installations: Use only a 45° double wye fitting.