

Features

- Brass construction.
- Compression valve.
- Pair of angle supplies with stop.
- Annealed vertical tube with union connection.
- 3/8" NPT connection with flange.
- Loose key stop.



Codes/Standards

ASME A112.18.1/CSA B125.1

NSF 61

NSF 372

All applicable US Federal and State material regulations

KOHLER® One-Year Limited Warranty

See website for detailed warranty information.

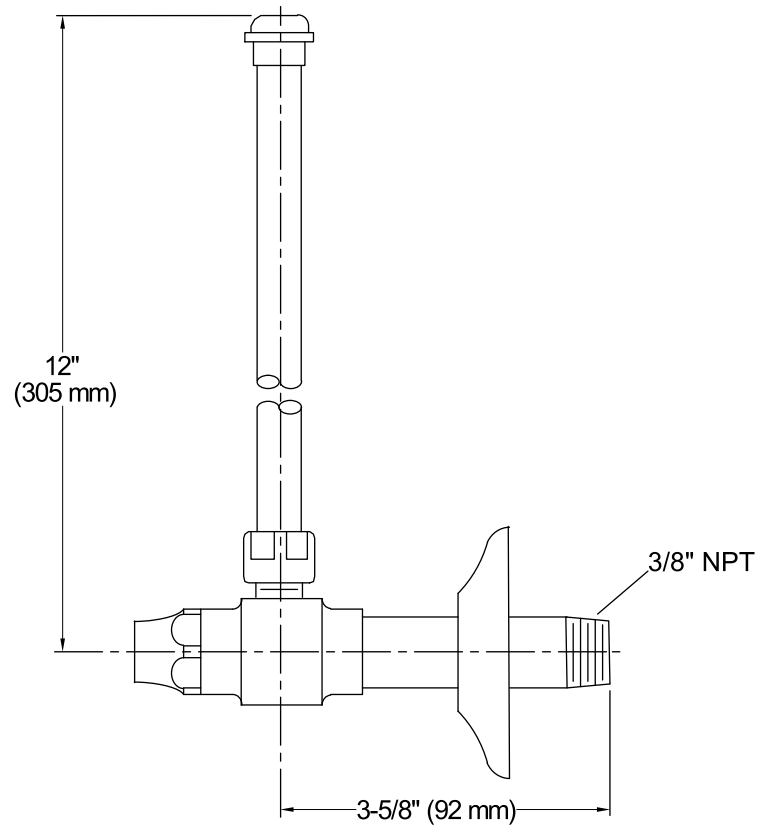

Technical Information

All product dimensions are nominal.

Notes

Install this product according to the installation guide.