



# Langlade® Smart Divide®

Top-mount Kitchen Sink  
**K-6626-3F**

## Features

- 33-inch minimum base cabinet width.
- KOHLER cast iron.
- Acid-resistant enamel finish.
- Double (equal) compartment.
- Top-mount.
- Smart Divide™ lowered divider.
- Single faucet hole with one accessory hole to the right and one accessory hole to the left.
- 33" (838 mm) x 22" (559 mm).

## Recommended Accessories

K-9000 P-Trap

## Optional Accessories

K-6061 Sink Rack  
K-6066 Sink Rack  
K-6545 Sponge Caddy  
K-8801 Sink Strainer



## Codes/Standards











ASME A112.19.1/CSA B45.2

## KOHLER® Enameled Cast Iron Kitchen Sink - Lifetime Limited Warranty

See website for detailed warranty information.

## Available Color/Finishes

*Color tiles intended for reference only.*

Color	Code	Description
	0	White
	FF	Sea Salt™
	96	Biscuit
	47	Almond
	FD	Cane Sugar™
	95	Ice™ Grey
	G9	Sandbar
	K4	Cashmere
	20	Suede
	KA	Black 'n Tan
	7	Black Black™

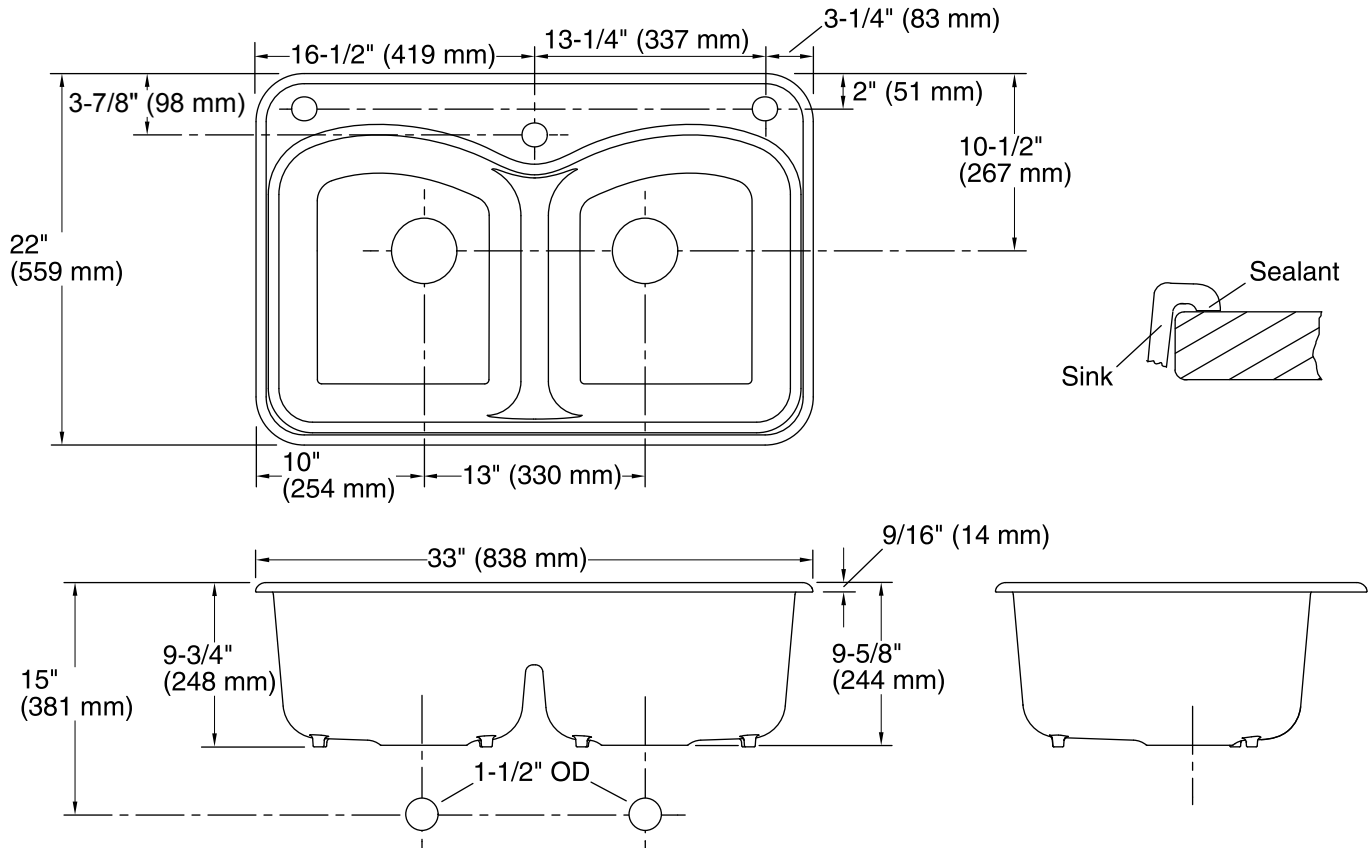

#### Technical Information

All product dimensions are nominal.

Bowl configuration: Double equal

Installation: Top-mount

Bowl area (Left) Length: 15" (381 mm)  
Width: 18-3/8" (467 mm)  
Bowl depth: 9" (229 mm)

Bowl area (Right) Length: 15" (381 mm)  
Width: 18-3/8" (467 mm)  
Bowl depth: 9" (229 mm)

Number of deck holes: 3

Faucet hole(s): 1-3/8" (35 mm)

Drain hole: 3-5/8" (92 mm)

Template: Top-mount, 1043753-7, required, included

#### Notes

Install this product according to the installation guide.