

Features

- 33-inch minimum base cabinet width.
- KOHLER cast iron.
- Acid-resistant enamel finish.
- Top-mount.
- Double (large/medium) bowls.
- Offset faucet ledge.
- Three faucet holes with one accessory hole to the right.
- 33" (838 mm) x 22" (559 mm)

Recommended Accessories

K-9000 P-Trap

Optional Accessories

K-6001 Sink Rack
K-6515 Cutting Board
K-6521 Sink Basket
K-8801 Sink Strainer



Codes/Standards











ASME A112.19.1/CSA B45.2

KOHLER® Enameled Cast Iron Kitchen Sink - Lifetime Limited Warranty

See website for detailed warranty information.

Available Color/Finishes

Color tiles intended for reference only.

Color	Code	Description
	0	White
	FF	Sea Salt™
	96	Biscuit
	47	Almond
	FD	Cane Sugar™
	95	Ice™ Grey
	G9	Sandbar
	K4	Cashmere
	20	Suede
	KA	Black 'n Tan
	7	Black Black™

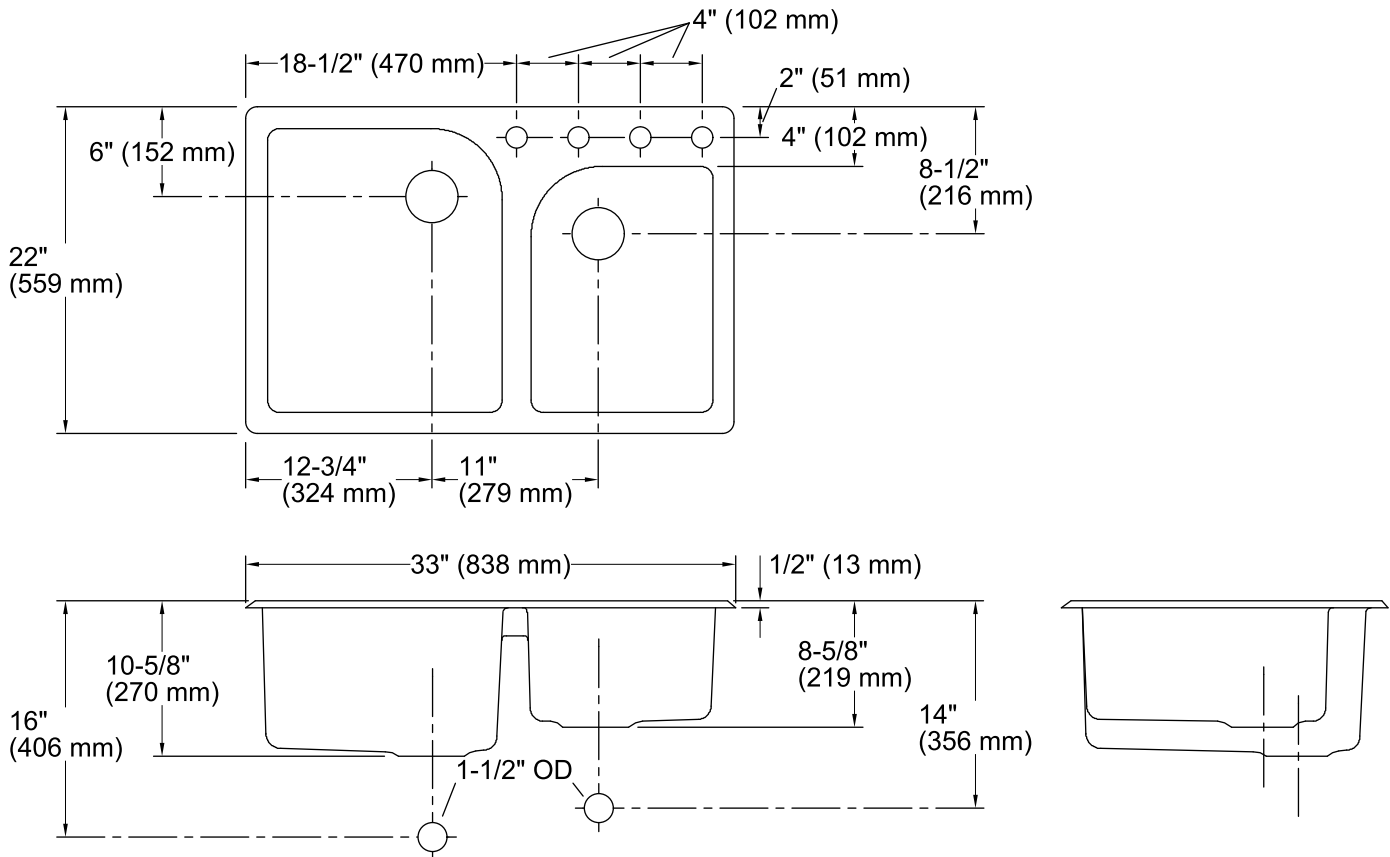

Technical Information

All product dimensions are nominal.

Bowl configuration: Large/medium

Installation: Top-mount

Cutout: Top-mount, 31-7/8" x 20-3/4" (810 mm x 527 mm) with 1-1/2" (38 mm) radius corners

Bowl area (Left) Length: 16" (406 mm)
Width: 19" (483 mm)
Bowl depth: 9-3/4" (248 mm)

Bowl area (Right) Length: 12" (305 mm)
Width: 17" (432 mm)
Bowl depth: 7-3/4" (197 mm)

Number of deck holes: 4

Faucet hole(s): 1-3/8" (35 mm)

Drain hole: 3-5/8" (92 mm)

Notes

Install this product according to the installation guide.