



Buy it for looks. Buy it for life.®

Specifications

DESCRIPTION

- Metal construction
- Installs on 10"(254mm) centers minimum
- Designed to be installed on finished decks up to 2-5/8" (67mm)
- 1/2" CC inlets and outlets
- Includes brass test plug

OPERATION

- Can be installed with any Moen deck mounted roman tub trim kit
- Rotate hot side handle counterclockwise to open (clockwise to close) and the cold side handle clockwise to open (counterclockwise to close)

FLOW

- Designed to deliver 13 gpm at 45 psi. (49L/min)

CARTRIDGE

- Nonmetallic and stainless steel materials

STANDARDS

- Designed and manufactured to comply with the applicable requirements of: ASME A112.18.1/CSA B-125.1 and all applicable requirements referenced therein

WARRANTY

- Lifetime limited warranty against leaks, drips and finish defects to the original consumer purchaser
- 5 year warranty if used in commercial installations

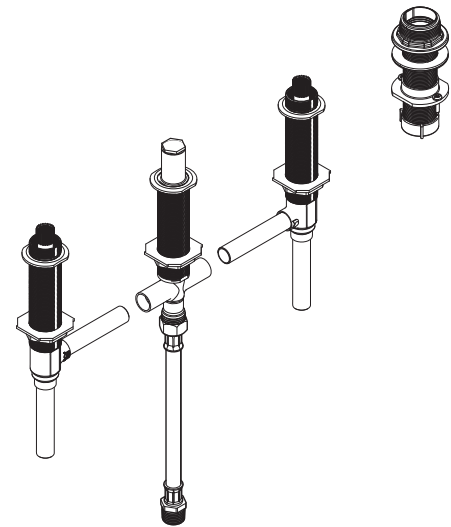

Roman Tub High Flow Rough-In Valve (Adjustable Type)

Model: 9792

(104465 Thermostatic mixing valve sold separately)

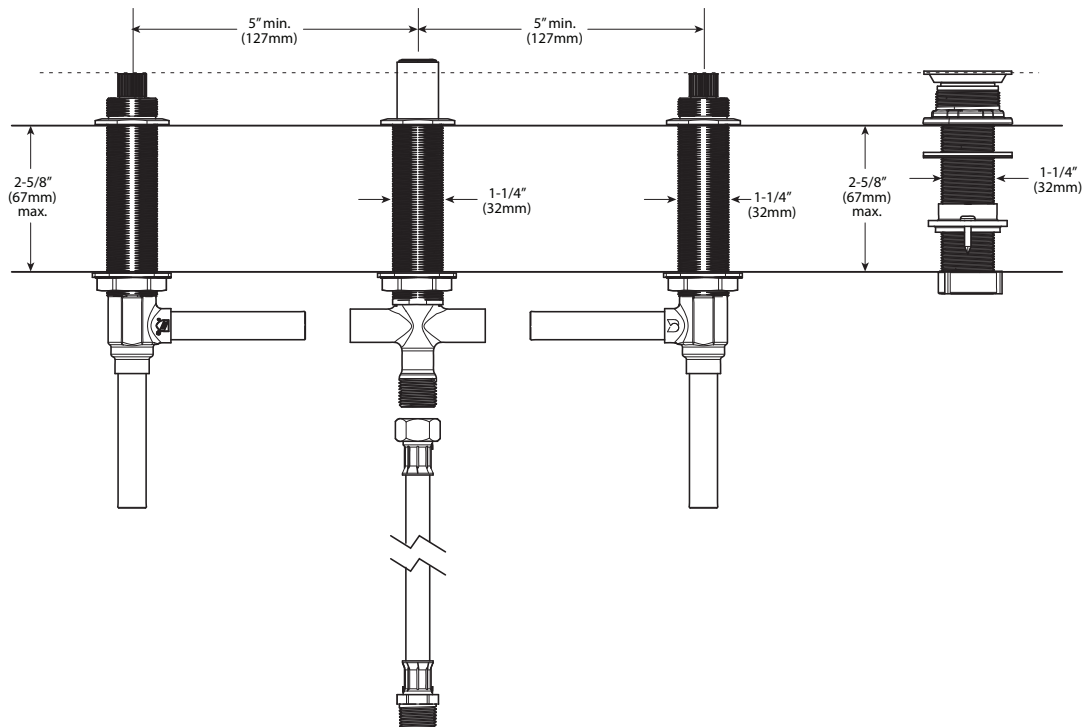

CRITICAL DIMENSIONS

(DO NOT SCALE)

FOR MORE INFORMATION CALL: 1-800-BUY-MOEN

www.moen.com