

CATALOG NUMBER	TYPE
PROJECT	

3" LEDme™ DOWNLIGHT **HR-LED331**

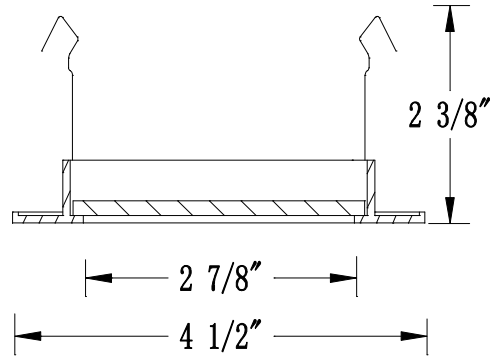







Ordering Matrix		
Series	Model Number	Finish(Trim)
[]	[]	[]
HR	LED331	WT = White CH = Chrome

Ordering Example (series – model number – finish): HR-LED331-WT/WT

Product Details	
Description:	Recessed trim with interior wove glass. For use with HR-LED309 series housings.
Materials:	Powder coated or plated brushed nickel finish on die-cast aluminum. Fingered retention clips firmly hold trim to housing.
Finish:	WT = white trim CH = Chrome trim
Listing:	UL & CUL Listed. Suitable for damp locations.

Specification Features
<ul style="list-style-type: none"> • Handles surfaces up to 3/4". • Wove lens helps to naturally diffuse the light, providing a comfortable feel at any viewing angle. • 5 years WAC Lighting product warranty.

Compatible Housings (Sold Separately)			
HR-LED309-NIC-W New construction IC housing Dimming with thermal protection 3 LEDs Max wattage: 6W Color Temperature: 3000K		HR-LED309-NIC-C New construction IC housing Dimming with thermal protection 3 LEDs Max wattage: 6W Color Temperature: 4500K	

Compatible Housings (Sold Separately)			
<p>HR-LED309-N-W</p> <p>New construction NON-IC housing</p> <p>Dimming with thermal protection</p> <p>3 LEDs</p> <p>Max Wattage: 10W</p> <p>Color Temperature: 3000K</p>		<p>HR-LED309-N-C</p> <p>New construction NON-IC housing</p> <p>Dimming with thermal protection</p> <p>3 LEDs</p> <p>Max Wattage: 10W</p> <p>Color Temperature: 4500K</p>	
<p>HR-LED309-RIC-W</p> <p>Remodel IC housing</p> <p>Dimming with thermal protection</p> <p>3 LEDs</p> <p>Max Wattage: 6W</p> <p>Color Temperature: 3000K</p>		<p>HR-LED309-RIC-C</p> <p>Remodel IC housing</p> <p>Dimming with thermal protection</p> <p>3 LEDs</p> <p>Max Wattage: 6W</p> <p>Color Temperature: 4500K</p>	
<p>HR-LED309-R-W</p> <p>Remodel NON-IC housing</p> <p>Dimming with thermal protection</p> <p>3 LEDs</p> <p>Max Wattage: 10W</p> <p>Color Temperature: 3000K</p>		<p>HR-LED309-R-C</p> <p>Remodel NON-IC housing</p> <p>Dimming with thermal protection</p> <p>3 LEDs</p> <p>Max Wattage: 10W</p> <p>Color Temperature: 4500K</p>	

Note: The full catalog number for a complete downlight includes the model numbers for both the trim and the housing.