

## MODEL:DEC1107

| NO. | ASSEMBLY NAME      | QUANTITY | NO.  | ASSEMBLY NAME     | QUANTITY |
|-----|--------------------|----------|------|-------------------|----------|
| (1) | CABINET            | 1        | (7)  | POP-UP WASTE      | 1        |
| (2) | HANDLE             | 3        | (8)  | FAUCET            | 1        |
| (3) | SCREW              | 7        | (9)  | MIRROR            | 1        |
| (4) | SELF-TAPPING SCREW | 7        | (10) | SIDE CABINET      | 1        |
| (5) | COUNTERTOP         | 1        | (11) | DECORATIVE COVERS | 2        |
| (6) | BASIN              | 1        |      |                   |          |

1

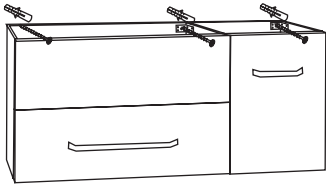

2

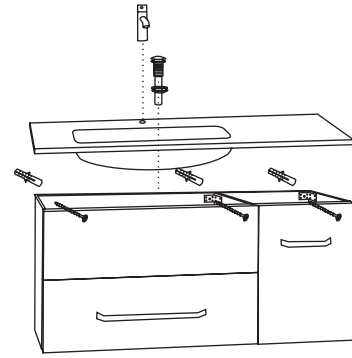

3

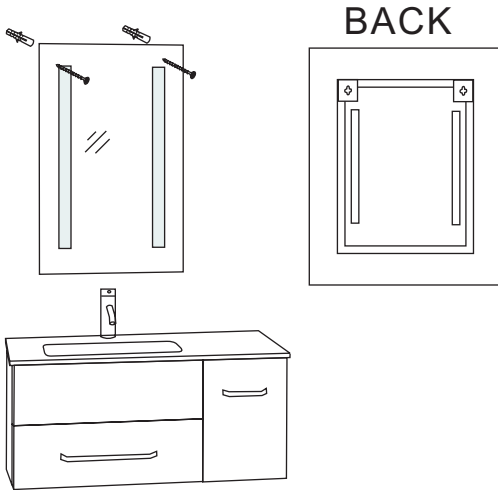

4

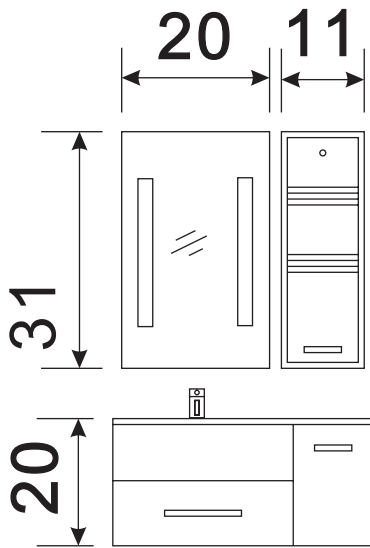
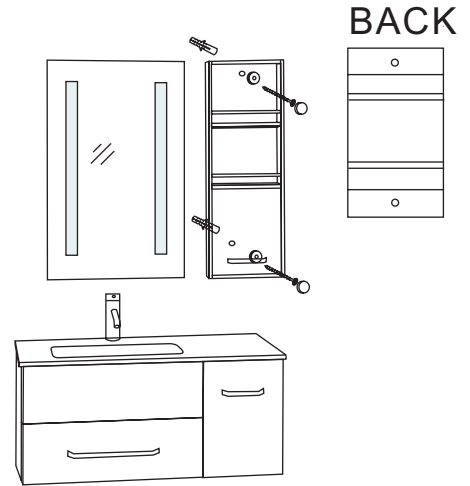

FRONT VIEW

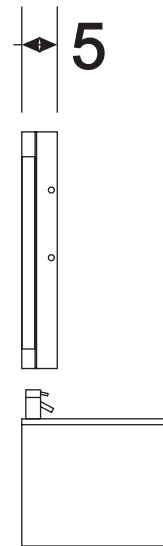

SIDE VIEW

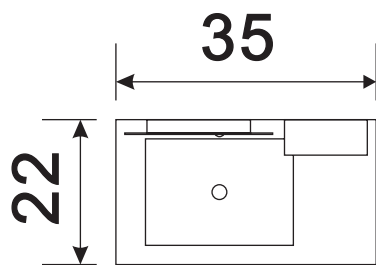

TOP VIEW

