

Dome-S-I Grande

HS246_SC2G60

1.0



GENERAL PRODUCT INFORMATION:

This product is suitable for indoor dry locations only.



This product can be dimmed with a standard incandescent dimmer.

CAUTION - RISK OF FIRE

This product requires installation by a qualified electrician. Before installing be sure to read all instructions and **TURN THE POWER TO THE ELECTRICAL BOX OFF.**

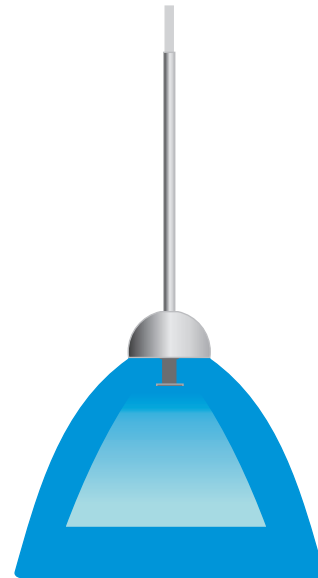

Install the Glass Shield and Lamp

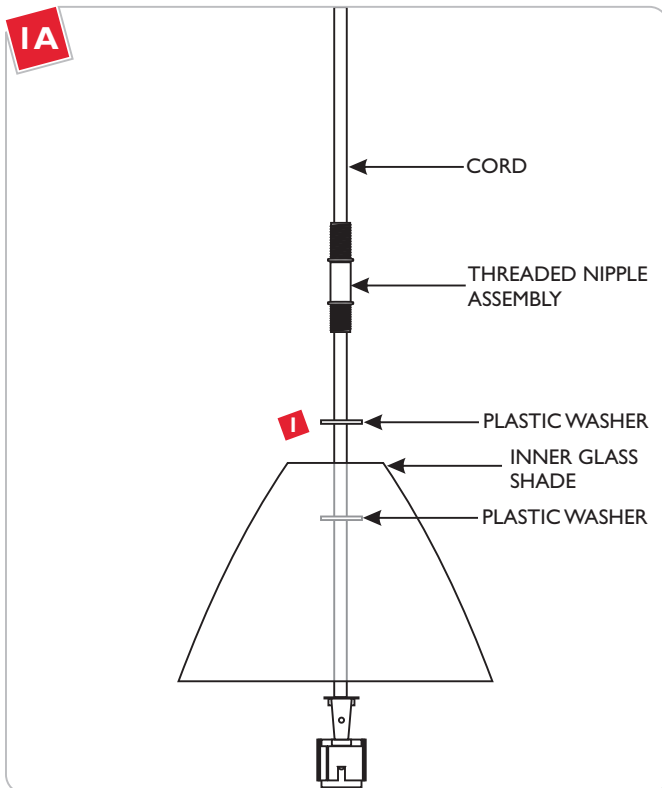

1 Feed the socket assembly cord through a plastic washer, inner glass shade, another plastic washer and threaded nipple assembly respectively.

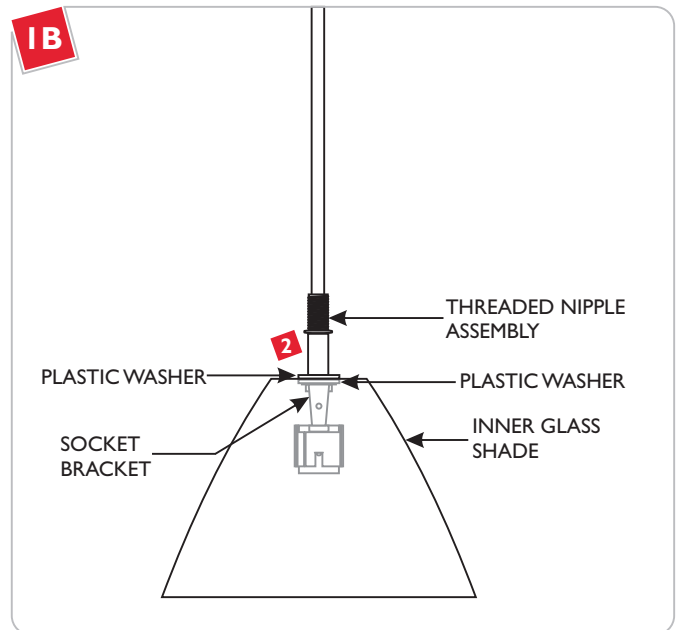

2 Secure the inner glass shade by tightening the threaded nipple assembly to the socket bracket.

NOTE: Do not over tighten the threaded nipple assembly which may cause the glass shade to break.

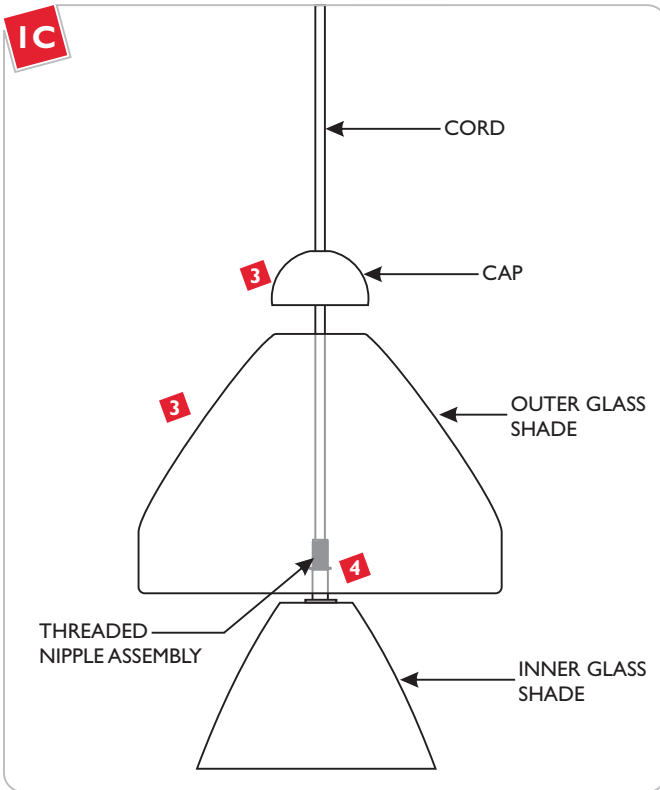

- 3** From the end of the cord, carefully slide the outer glass shade and cap completely down and lay it on the threaded nipple assembly.
- 4** Secure the outer glass shade in place by tightening the cap to threaded nipple assembly

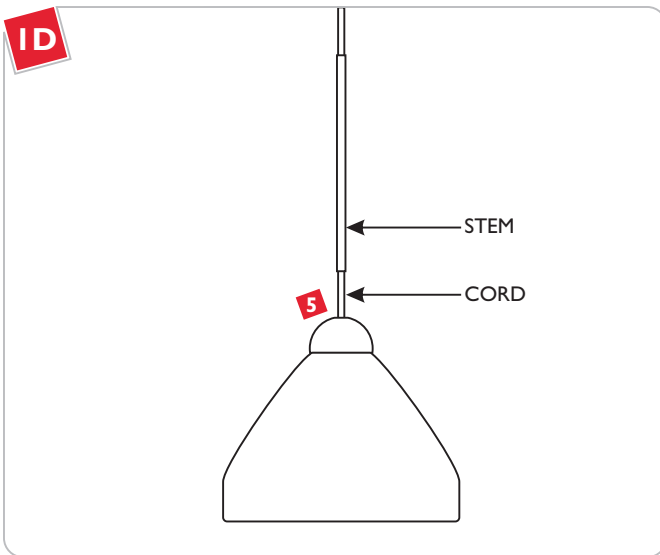

- 5** From the end of the cord slide the stem completely down into the cap.

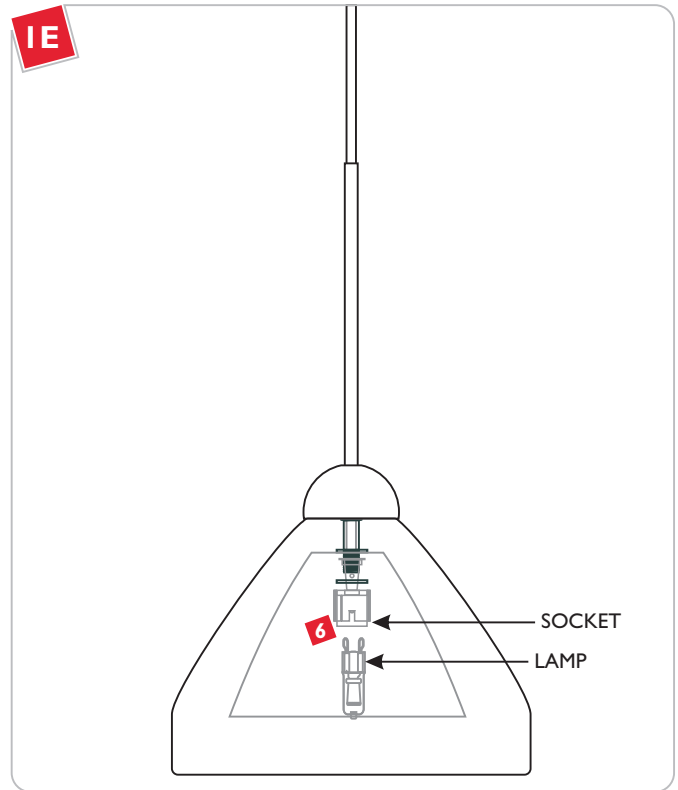

NOTE: To reduce the risk of a burn or electric shock during relamping, disconnect the power to the fixture.

NOTE: The G9 lamp has an integral glass envelope and is thus safe to be used without a lamp shield.

Use **MAX** 120 Volt, **60** Watt Type T4, G9 Base, Bi-Pin Halogen Lamp.

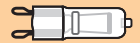

- 6** Push the lamp pins completely into the socket holes .
- 7** Refer to the instructions provided with the canopy to install the fixture.

IMPORTANT SAFETY INSTRUCTIONS

To reduce the risk of fire, electrical shock, exposure to excessive UV radiation, or injury to person:

- Use this fixture indoors only.
- Do not look directly at the lighted lamp.
- Do not remain in light if skin feels warm.
- Risk of fire: Use only the type of lamp and maximum wattage indicated in this instruction manual.
- Never cover the halogen lamp and never place flammable material close to your fixture.
- Never turn the fixture on and off by connecting and disconnecting the halogen lamp.
- Do not touch the fixture shade while the fixture is on. This surface may be HOT.

Halogen Lamp General Information

- A new halogen lamp may smoke slightly when it is used for the first time. This is perfectly normal; the protective coating is simply being vaporized.

Two Tips For Prolonging Halogen Lamp Life

- First avoid touching the lamp with bare hands during installation. Any contaminant, even the oil from your hands can deteriorate the lamp. Rubbing alcohol can be used to remove any contaminant.
- Second, do not run the lamps at full power when you do not need to. However, if dimming the fixture for an extended period of time, occasionally bring the light up to full brightness for a few minutes to complete the halogen cycle.

SAVE THESE INSTRUCTIONS!



7400 Linder Ave, Skokie, IL 60077

800.323.3226 - 847.626.6300

www.lblighting.com

© 2008 LBL Lighting. All rights reserved. The "LBL Lighting" graphic is a registered trademark of LBL Lighting. LBL Lighting reserves the right to change specifications for product improvements without notification.

A Generation Brands Company