

GENERAL DESCRIPTION:

Concealed, Sensor Operated Selectronic™ Flush Valve with Wall Box (Front Access) for 3/4" back spud urinal.

Inlet includes 3/4" I.P.S. angle stop (with integral back-flow preventer & wheel handle) and sweat solder kit. Outlet includes 3/4" vacuum breaker with adjustable tailpiece, spud coupling and flange.

PRODUCT FEATURES:

- Electronic flush valve with Selectronic™ proximity system for hygienic “Hands Free” operation
- Self-Cleaning Piston helps prevent clogging & reduces maintenance
- Positive Seal ensures leak-free performance without the chance of warping or cracking
- Fully Mechanical Manual Override Button can flush toilet during a power outage
- Range can be adjusted manually or by remote control
- State-of-the Art electronics eliminates false flushes
- Sensor & Electronic controls are hermetically sealed to ensure reliable operation
- Automatic flushes after 24 hours of non-use to maintain trap seal & clean fixture
- Stadium Feature - valve automatically switches to water savings mode during periods of heavy usage
- Fail-Safe - valve automatically closes on loss of power; remains closed during start-up
- 3 second flush delay
- Low Battery indicator
- All exposed parts are chrome plated
- ADA compliant

MODEL NUMBER:

- 6063.515.007 DC Powered, 0.5 gpf**
 Battery included
FRONT ACCESS
 Manual Override
 Stainless Steel Wall Box And Cover Plate
- 6062.505.007 Plug-In AC Powered, 0.5 gpf**
SAME AS ABOVE
 AC Supply (M950169-0070A) included
- 6061.505.007 Multi-AC Powered, 0.5 gpf**
SAME AS ABOVE
 10' Extension Cable included
 One AC Supply (sold separately) supplies enough power to run up to 15 flush valves

OPERATING PRESSURE:

Overall Range: 20-125 psi **
 Recommended: 25 psi (flowing) - 80 psi (static)

**Water pressure over 80 psi is not recommended with most plumbing fixtures

BATTERY LIFE:

Up to 4-year life (approx. 200,000 cycles)

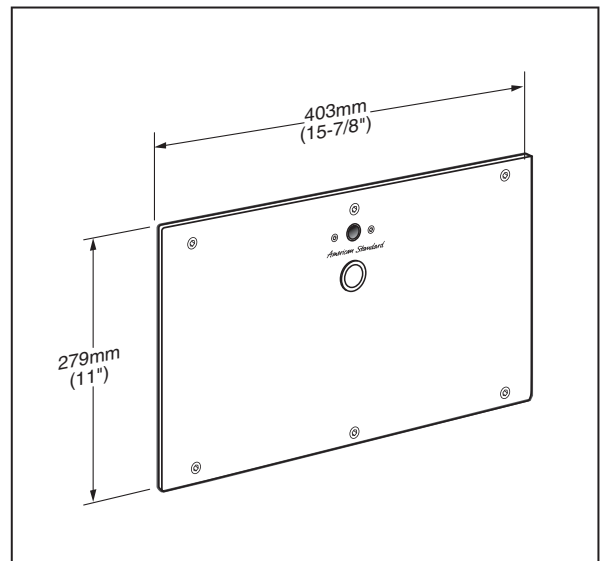

RECOMMENDED SPECIFICATION:

Electronic proximity infrared sensor activated flush valve for 3/4" back spud urinal shall feature self-cleaning piston valve. Valve must automatically remain closed during start-up, close automatically upon loss of power, and include a fully mechanical manual override button to allow for flushing without power. Shall include stadium mode that switches to water savings mode during periods of heavy usage. Includes cast brass valve body, stainless steel wall box and cover plate with vandal-resistant screws. Angle stop and vacuum breaker included. Must be installed and maintained from the front. 0.5 gpf / 1.9 Lpf. Flush valve shall be American Standard Model # 606_515.007.

LISTINGS:

- ASSE 1037
- ANSI/ASME A112.19.2
- ADA Compliant

