

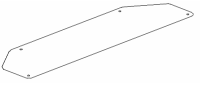











Model TVM-060

Components List

| Part Name | Part Description | | | Qty |
|-----------|-------------------------------|-----------------------------------|---|-----|
| | Description | Specification | Figure | |
| T Glass | Glass for top shelf | Size:1530*450mm Thickness:12mm |  | 1 |
| M Glass | Glass for middle shelf | Size:1530*425mm Thickness:6mm |  | 1 |
| B Glass | Glass for bottom shelf | Size:1530*450mm Thickness:6mm |  | 1 |
| T-L | Long tube | Length:268mm Diameter:50mm |  | 4 |
| T-S | Short tube | Length:190mm Diameter:50mm |  | 4 |
| FT | Foot tube | Length:70mm Diameter:50mm |  | 4 |
| CC-L | Chrome Cap(Large) | Diameter:50mm Thickness:8mm |  | 4 |
| CC-S | Chrome Cap (Small) | Diameter:28mm Thickness:8mm |  | 4 |
| I B-1 | I bolt (NO.1) | Length:35mm Diameter:10mm |  | 4 |
| I B-2 | I bolt (NO.2) | Length:50mm Diameter:10mm |  | 8 |
| I B-3 | I bolt (NO.3) | Length:45mm Diameter:6mm |  | 4 |
| T E S | Tube end seal | Diameter:50mm Thickness:2mm |  | 20 |
| CT | Cable Tidy | Size:472*144mm Thickness:20mm |  | 1 |
| TOOL-1 | 5# Tool (Screw IB-1 and IB-2) | |  | 1 |
| TOOL-2 | 3# Tool(Screw IB-3) | |  | 1 |

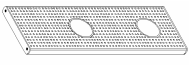
Model TVM-060

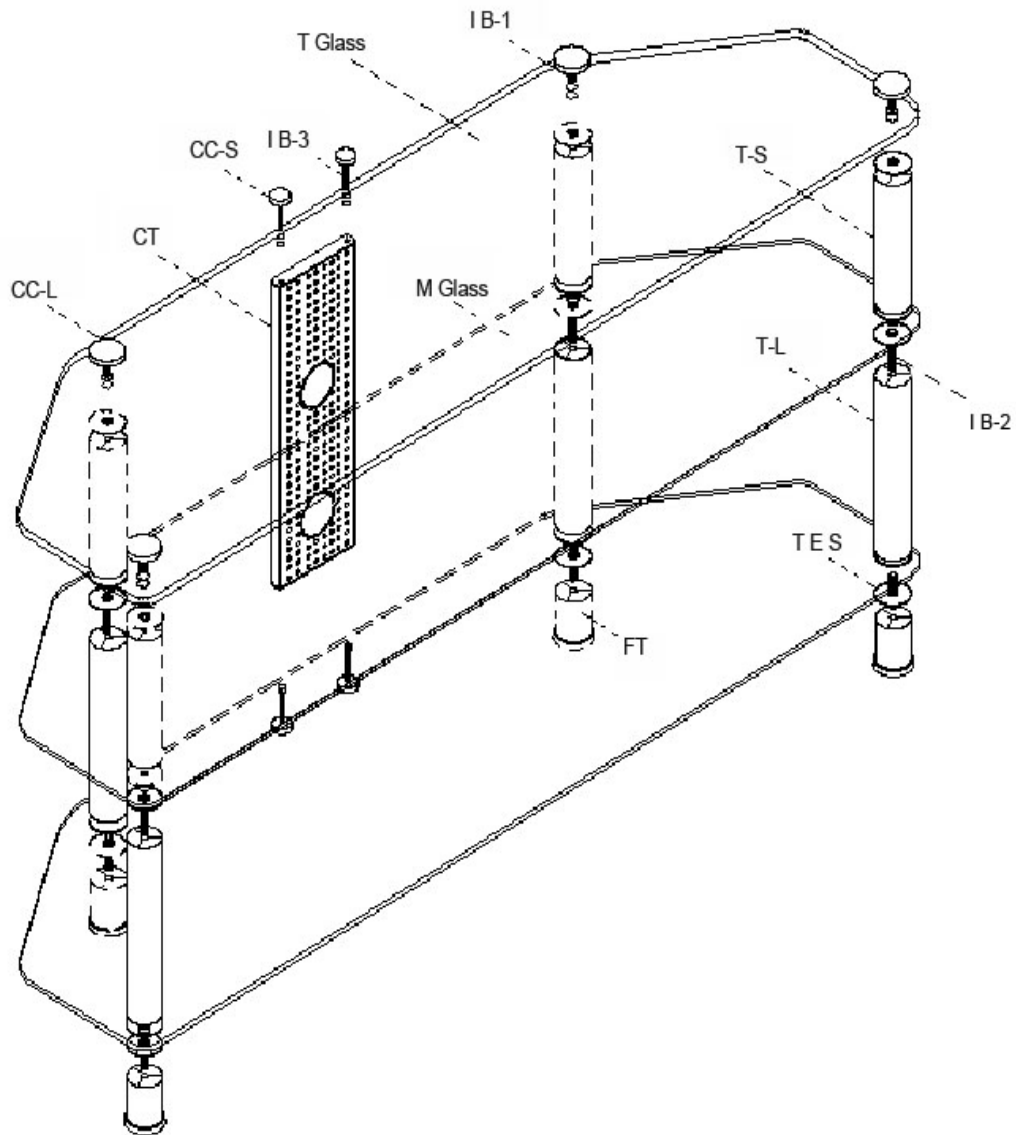

Model TVM-060

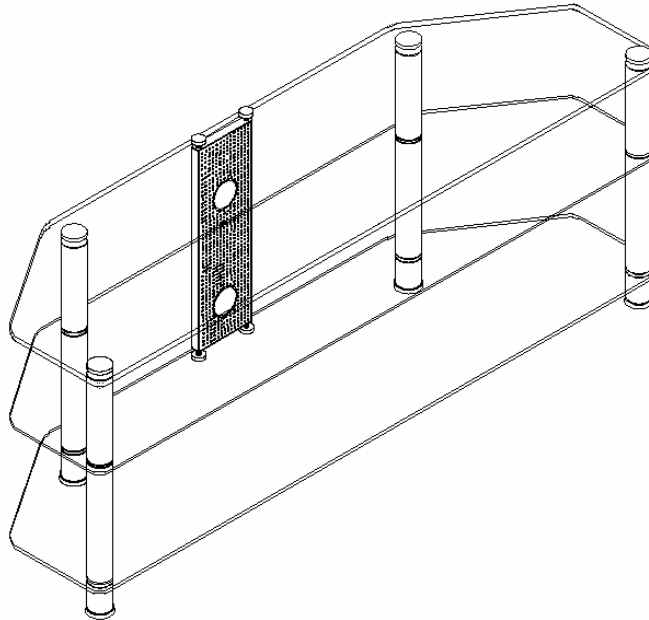

Stage 1

Please note stand is best assembled from the bottom up.

- 1.1 Screw in I bolts (I B-2) to the top of each foot tube (FT).
- 1.2 Place bottom shelf (B Glass) in position over each foot tube leg with I bolts passing through holes in each corner of the shelf. Then screw long tubes (T-L) onto each exposed bolt until tight.
- 1.3 Screw in I bolts (I B-2) to the top of each long tube (T-L).

Stage 2

- 2.1 Place middle shelf (M Glass) in position over each long tube leg with I bolts passing through holes in each corner of the shelf. Then screw short tubes (T-S) onto I bolts until tight.
- 2.2 Screw in I bolts (I B-1) to top of short tubes.
- 2.3 Place top shelf (T Glass) over I bolts resting on short tubes.
- 2.4 Attach cable tidy to top glass and bottom glass with small chrome cap (CC-S) ---- screw I bolts(I B-3) to small chrome cap. Then screw I bolts through the cable tidy nuts.
- 2.5 Secure top glass with large chrome caps (CC-L)