













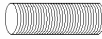

Components List

Part Name	Description	Qty
TB Glass	Glass for top or bottom shelves 	2
M Glass	Glass for middle shelf 	1
T-L	Long tube (bottom shelf) 	2
T-S	Short tube (top shelf) 	2
CC-L	Chrome Cap (large) 	2
CC-S	Chrome Cap (small) 	2
I B-1	I bolt (No.1) 	2
I B-2	I bolt (No.2) 	2
I B-3	I bolt (No.3) 	4
I B-4	Foot blot(NO.4) (Attached in the cable tidy) 	2
T E S	Tube send seal 	10
CT	Cable Tidy 	1
F-WD	Foot (wood support) 	1
FC-TB	Foot cap with tube and bolt (Gray plastic) 	2
TOOL-1	5# Tool (screw IB-1 and IB-2) 	1
TOOL-2	3# Tool (screw IB-3) 	1

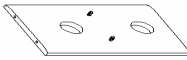
Assembly Instructions

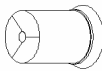
Model TVM-020

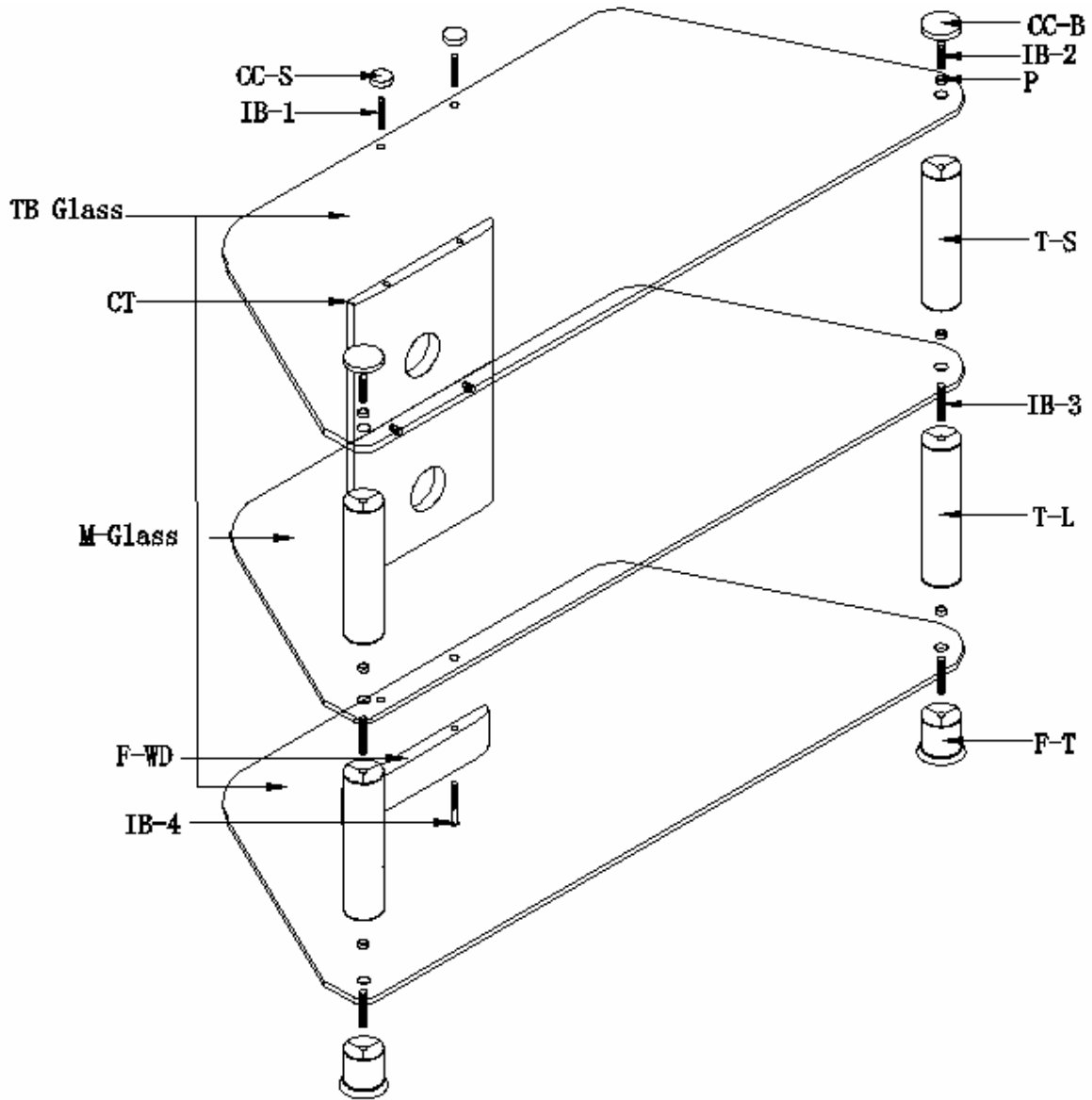

Model TVM-020

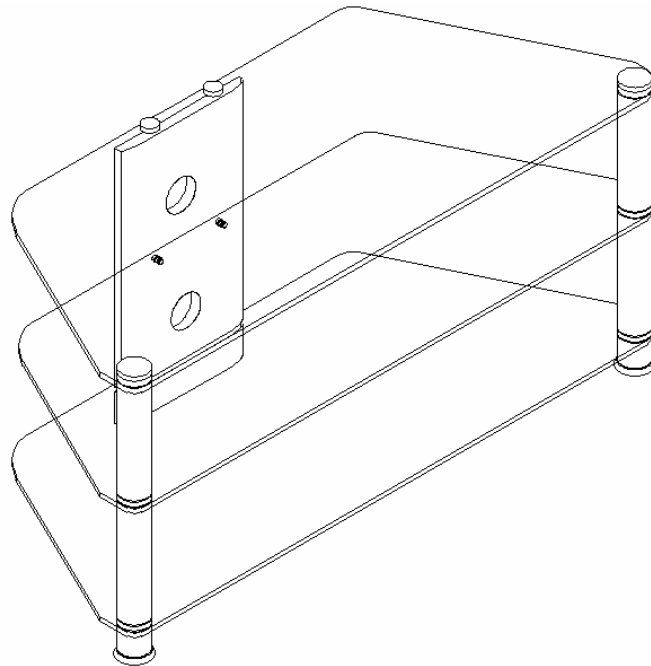

Stage 1

Please note stand is best assembled from the bottom up.

- 1.1 Place foot bolts through bottom shelf and the holes at the bottom of the cable tidy. Then screw the foot bolts into the cable tidy nuts until tight.
- 1.2 Screw in the I bolts to top of each foot tube.
- 1.3 Place I bolts in the foot tubes through bottom shelf. Then screw long tubes onto each exposed bolt until tight.
- 1.4 Screw in I bolts to the top of each long tube.
- 1.5 Place middle shelf in position over each tube leg with I bolts passing through holes in each corner of the shelf and resting on support pegs located on cable tidy.

Stage 2

- 2.1 Screw short tubes onto I bolts until tight.
- 2.2 Screw in I bolts to top of short tubes.
- 2.3 Place top shelf over I bolts resting on short tubes.
- 2.4 Secure top glass with chrome caps.

