



# Birlea

Suppliers of inspiration

Vendor: S000139



## ASSEMBLY INSTRUCTIONS LYNX 3 DOOR 2 DRAWER ROBE

**IMPORTANT: READ THESE INSTRUCTIONS CAREFULLY BEFORE ASSEMBLING OR USING YOUR LYNX 3 DOOR 2 DRAWER ROBE.**

PLEASE KEEP THESE INSTRUCTIONS FOR FUTURE REFERENCE.

### HEALTH & SAFETY:

DO NOT use this item if any parts are missing, damaged or worn.

DO NOT use this item unless all fixings are secured.

Please keep small parts out of reach of children.

Always use on a level, even surface.

### CARE & MAINTENANCE:

Assemble in the room of use.

Assembly should be carried out with this item laying flat, not standing upright.

Assemble on a soft, clean surface to prevent damages.

To remove the printed numbers on the pieces, use a moistened cloth.

Periodically check all screws & fixings to ensure they are secure.

DO NOT push the item as this will damage the legs.





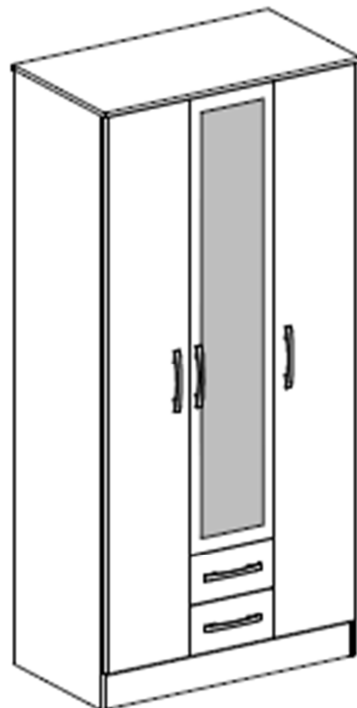



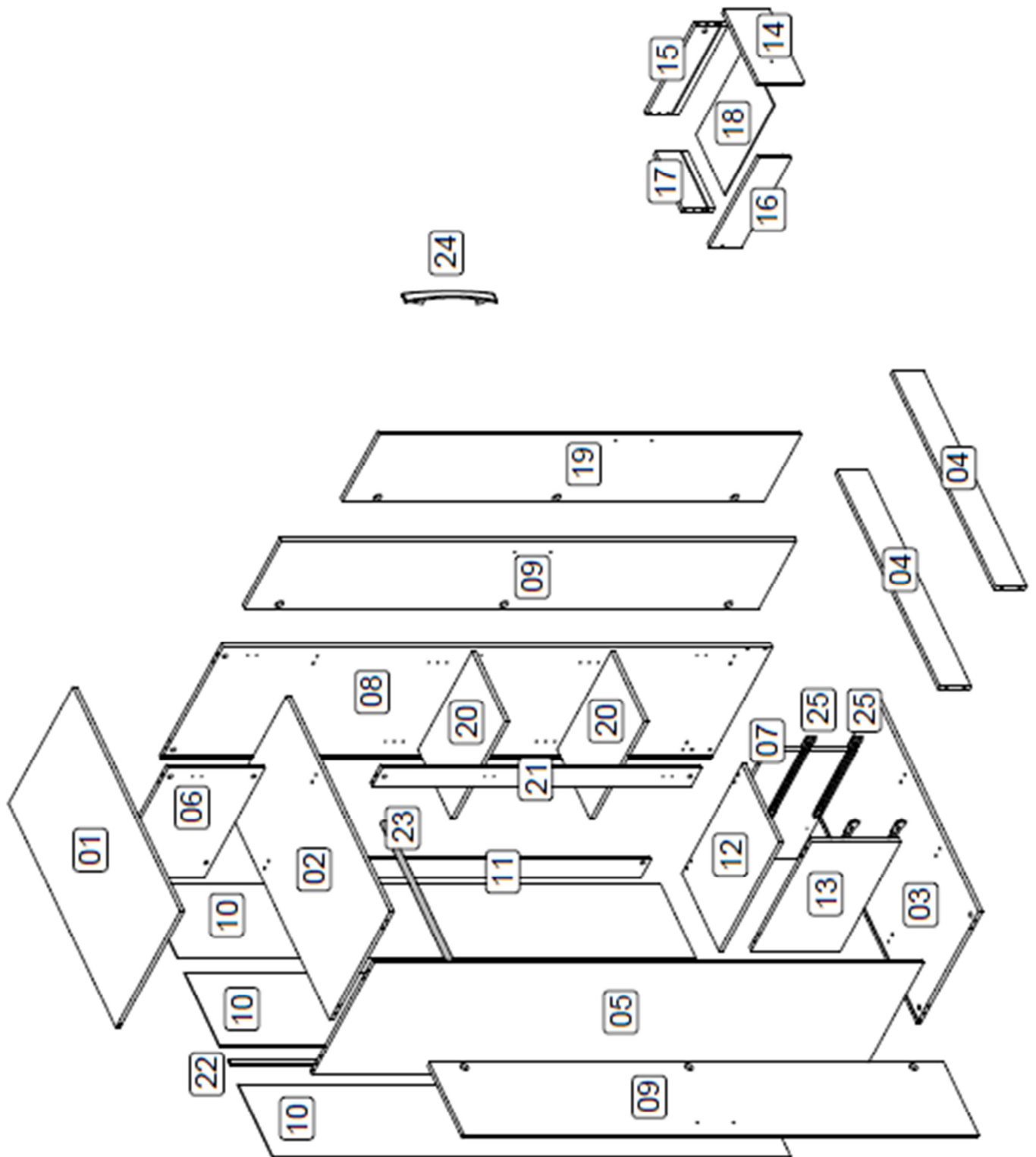





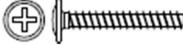

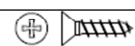
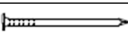

Always lift the item with two people to reposition.

Keep any sharp objects away from the item.



[www.birlea.com](http://www.birlea.com)

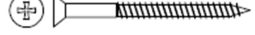

Parts List				Hardware List (found in box 2)		
Part	Description	Box	Qty	Part	Description	Qty
1	Top Panel	1	1	A	8 x 30 mm Wooden Dowel 	44
2	Shelf	1	1	B	Simple Minifix Screw 	20
3	Base Panel	1	1	C	Cam Lock 	28
4	Plinth	2	2	D	Plastic Cap 	24
5	Left Panel	1	1	E	8 x 50 mm Wooden Dowel 	4
6	Shelf Divider	1	1	F	3.5 x 25 mm Screw 	10
7	Drawer Cabinet Right Panel	1	1	G	3.5 x 20 mm Screw 	2
8	Right Panel	1	1	H	3.5 x 14 mm Screw 	36
9	Door	2	2	I	10 x 10 mm Tack 	11
10	Back Panel	2	3	J	Small Plastic Foot 	4
11	Back Support	1	1	K	Hinge 	9
12	Drawer Cabinet Top Panel	1	1	L	Hinge Bracket 	9
13	Drawer Cabinet Left Panel	1	1	M	3 x 14 mm Screw 	25
14	Drawer Front	1	2	N	Close Rail Support 	1
15	Right Side Drawer Panel	1	2	O	Rail Support 	1
16	Left Side Drawer Panel	1	2	P	Double Minifix Screw 	4
17	Back Drawer Panel	1	2	Q	Metal Claw 	7
18	Drawer Base	1	2	R	Glue 	1
19	Mirrored Door	2	1	S	4.5 x 45 mm Screw 	8
20	Shelf	1	2	T	Metallic Shelf Support 	8
21	Front Support	1	1	U	Crayon 	3
22	Spine	1	1	** You will need a small mallet and a screwdriver for assembly		
23	Hanging Rail	1	1			
24	Handle	2	5			
25	Drawer Runners	2	4			

Step 1: Prepare the parts for assembly using hardware parts A, B, E, G, H, I, J, K, L, M, N, O and R. You will need to use a small mallet and a screwdriver (not provided).

DO NOT use any power tools as this may damage the frame and will invalidate any claim.

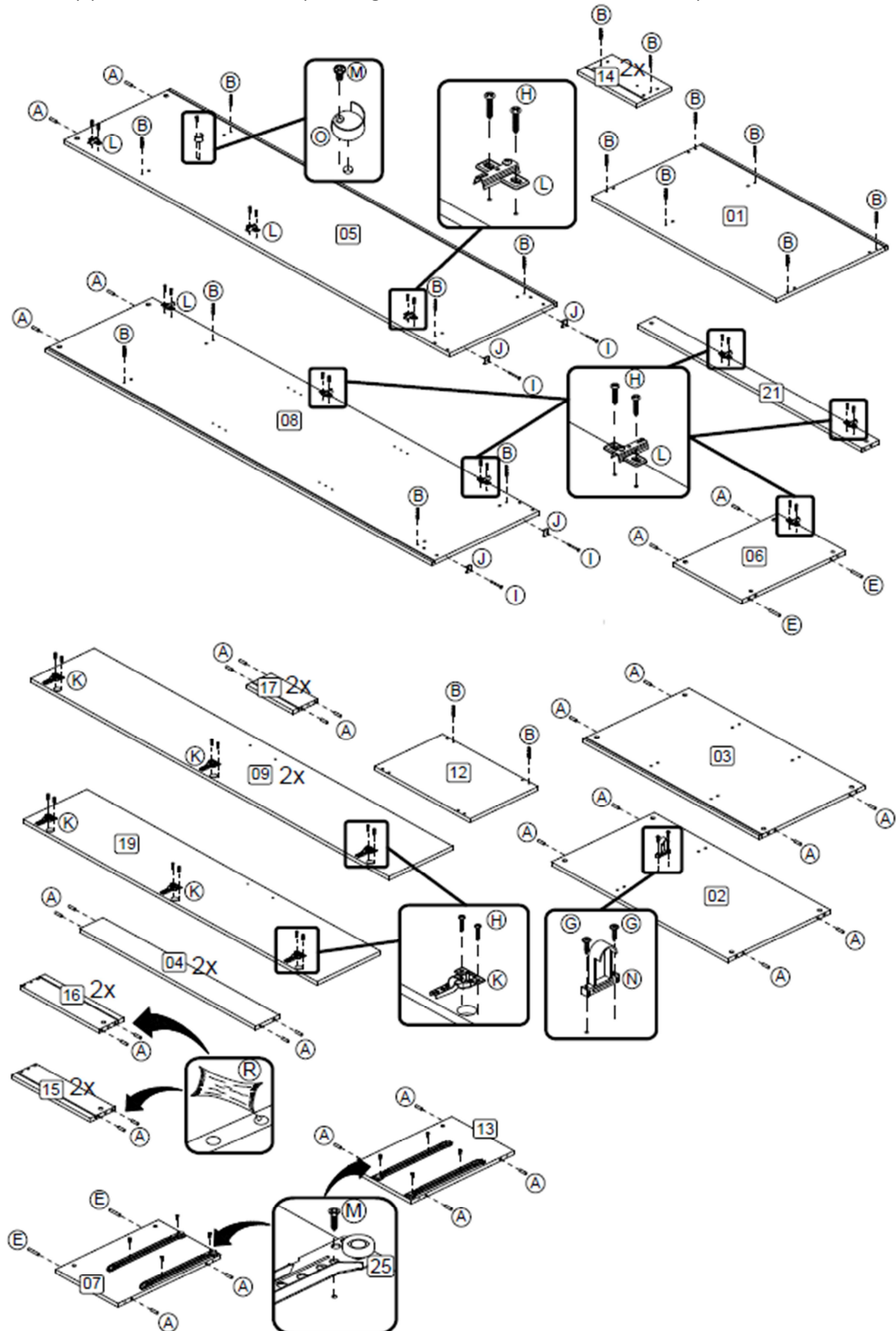

Step 2: Attach the drawer cabinet right panel (7) and drawer cabinet left panel (13) to the base panel (3) using hardware part S and a screwdriver (not provided).

DO NOT use any power tools as this may damage the frame and will invalidate any claim.

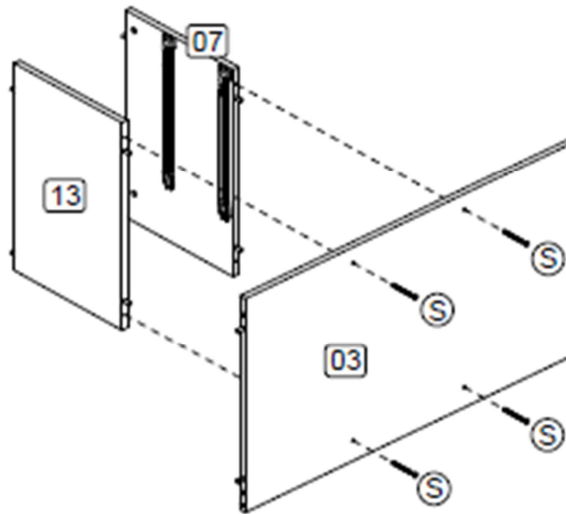

Step 3: Attach the base panel (3) and plinths (4) to the right panel (8) using hardware parts C and D with a screwdriver (not provided).

DO NOT use any power tools as this may damage the frame and will invalidate any claim.

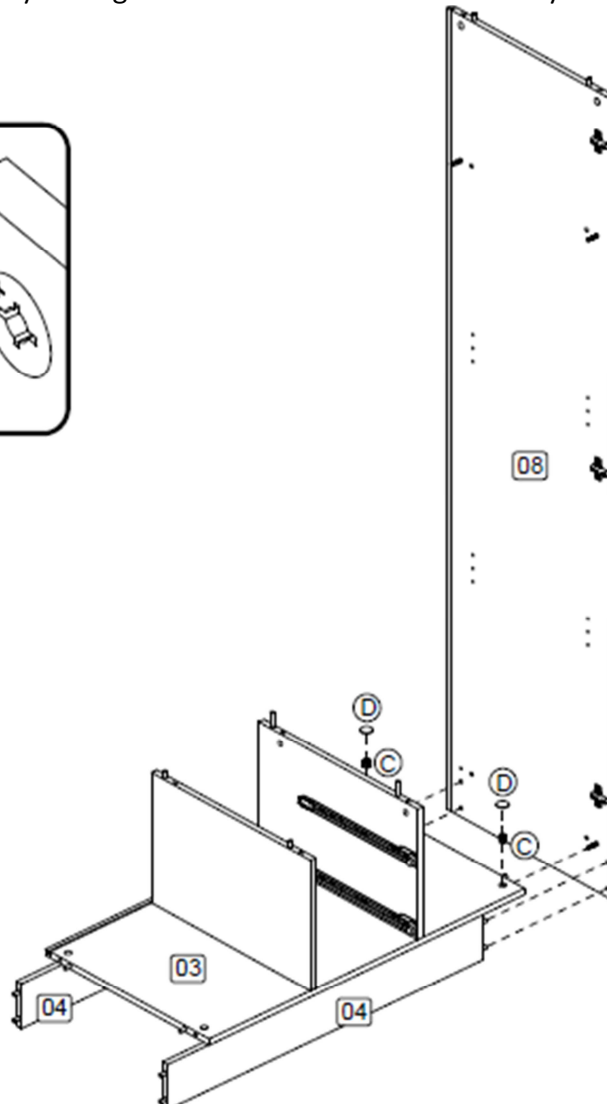
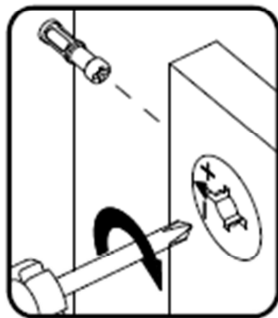

Step 4: Attach the drawer cabinet top panel (12) using hardware parts P and C. Attach the front support (21) and back support (11) using hardware parts C and D. You will need to use a screwdriver (not provided). DO NOT use any power tools as this may damage the frame and will invalidate any claim.

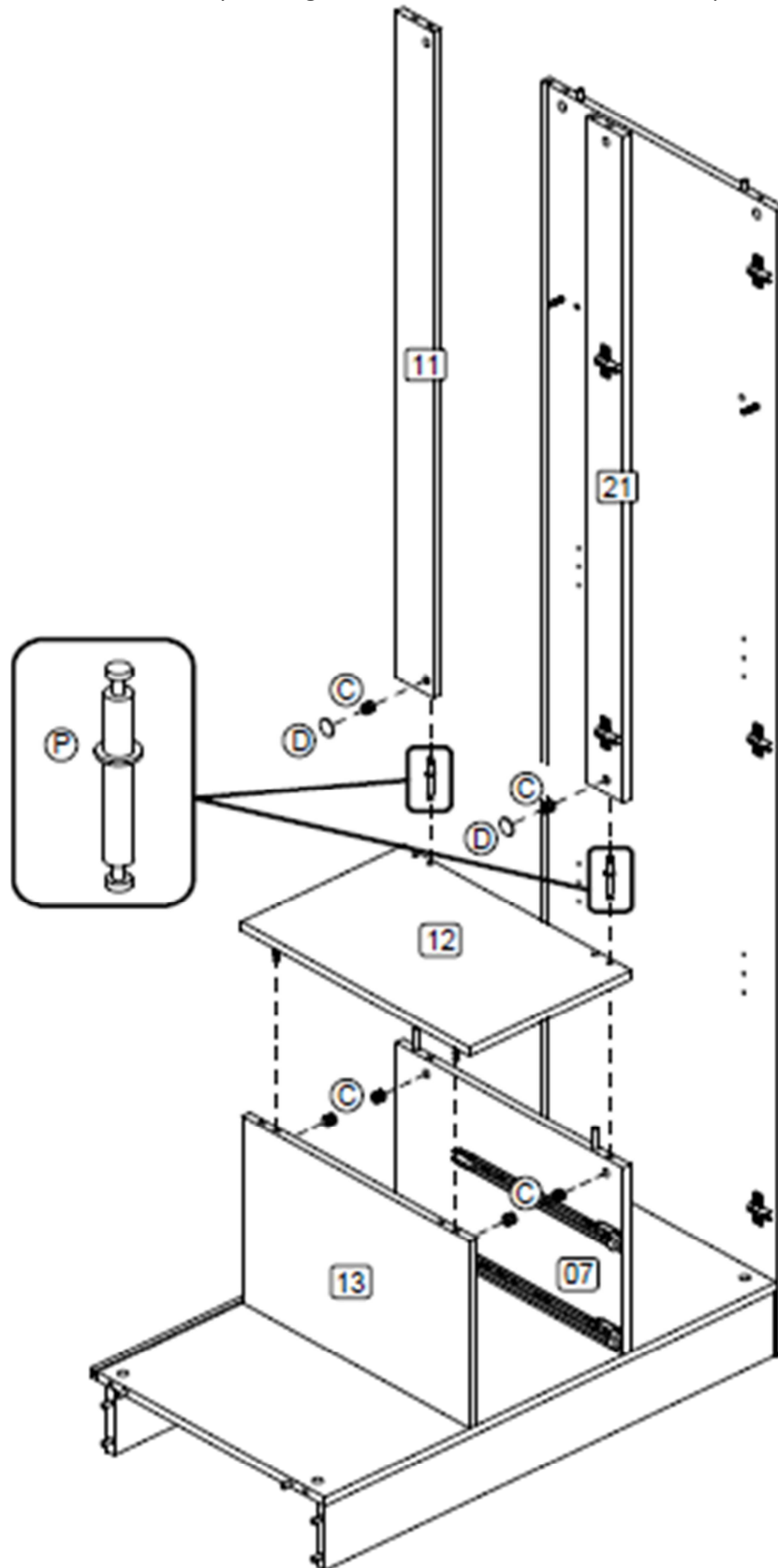

Step 5: Attach the shelf (2) using hardware parts C and D with a screwdriver (not provided).  
DO NOT use any power tools as this may damage the frame and will invalidate any claim.

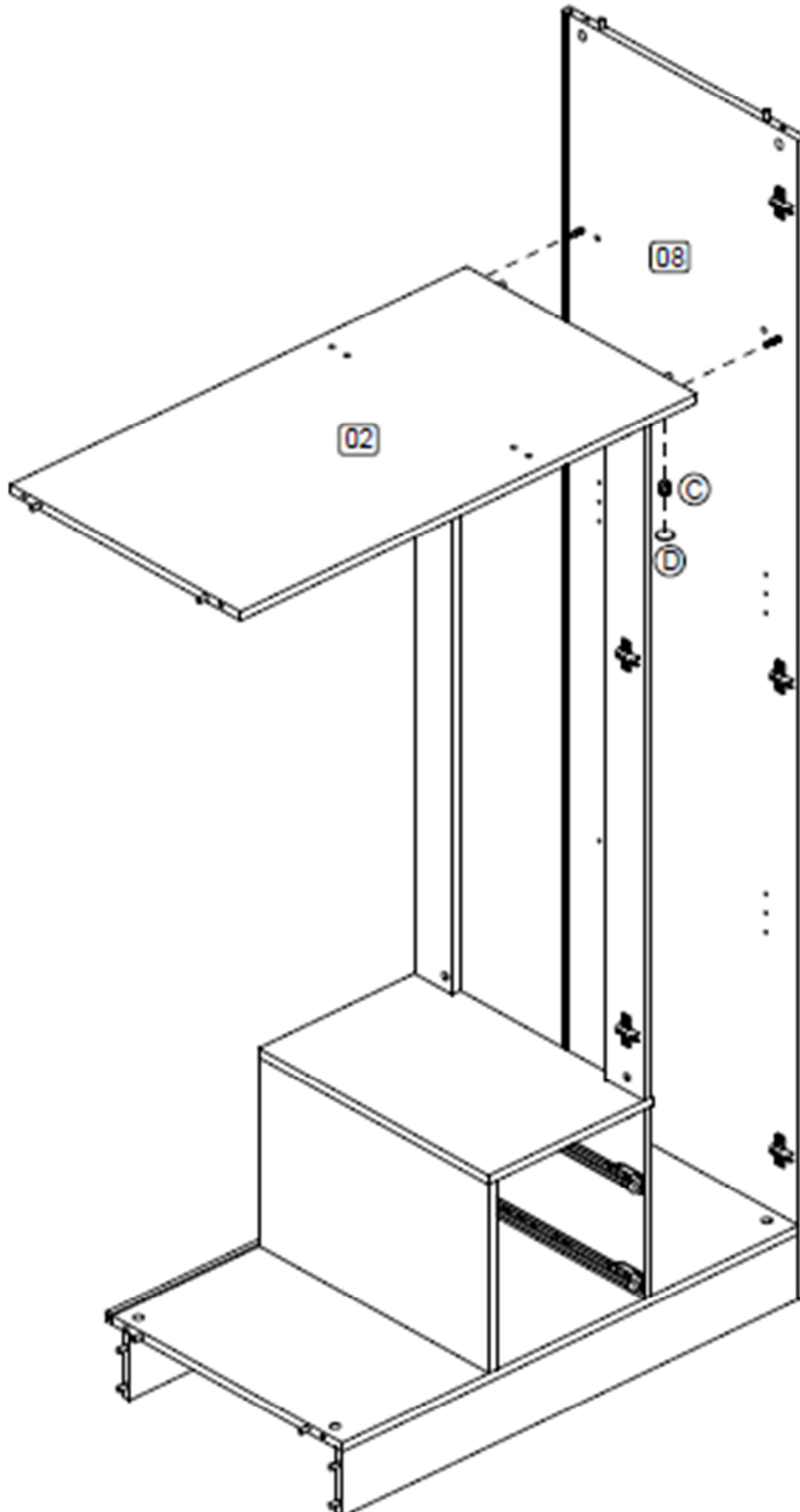

Step 6: Secure the shelf (2) to the back support (11) and front support (21) using hardware parts C, D and P. Fix the shelf divider (6) to the shelf (2) using hardware parts C and D. You will need to use a screwdriver (not provided).

DO NOT use any power tools as this may damage the frame and will invalidate any claim.

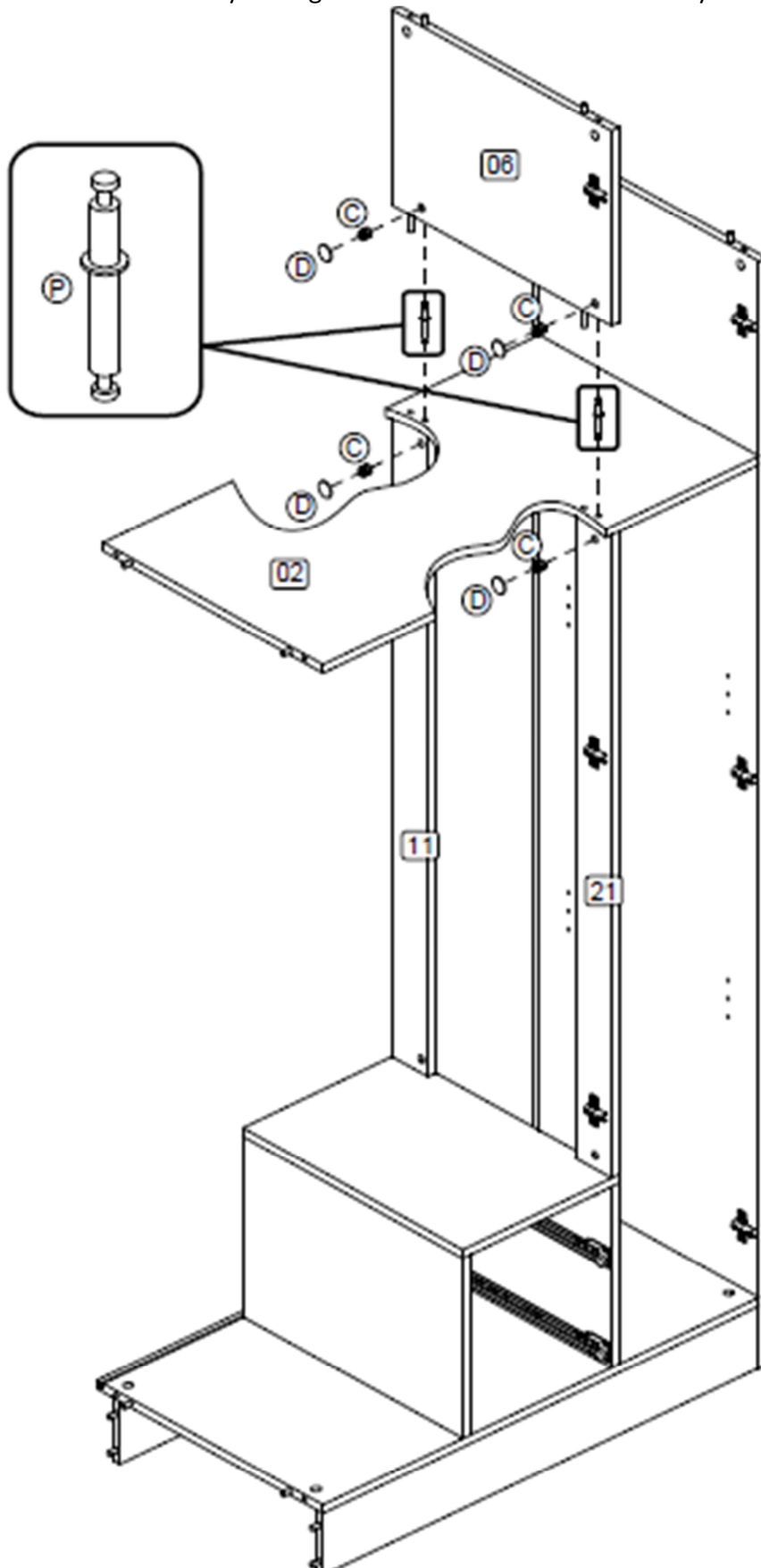



Step 7: Attach the left panel (5) using hardware parts C and D with a screwdriver (not provided).  
DO NOT use any power tools as this may damage the frame and will invalidate any claim.

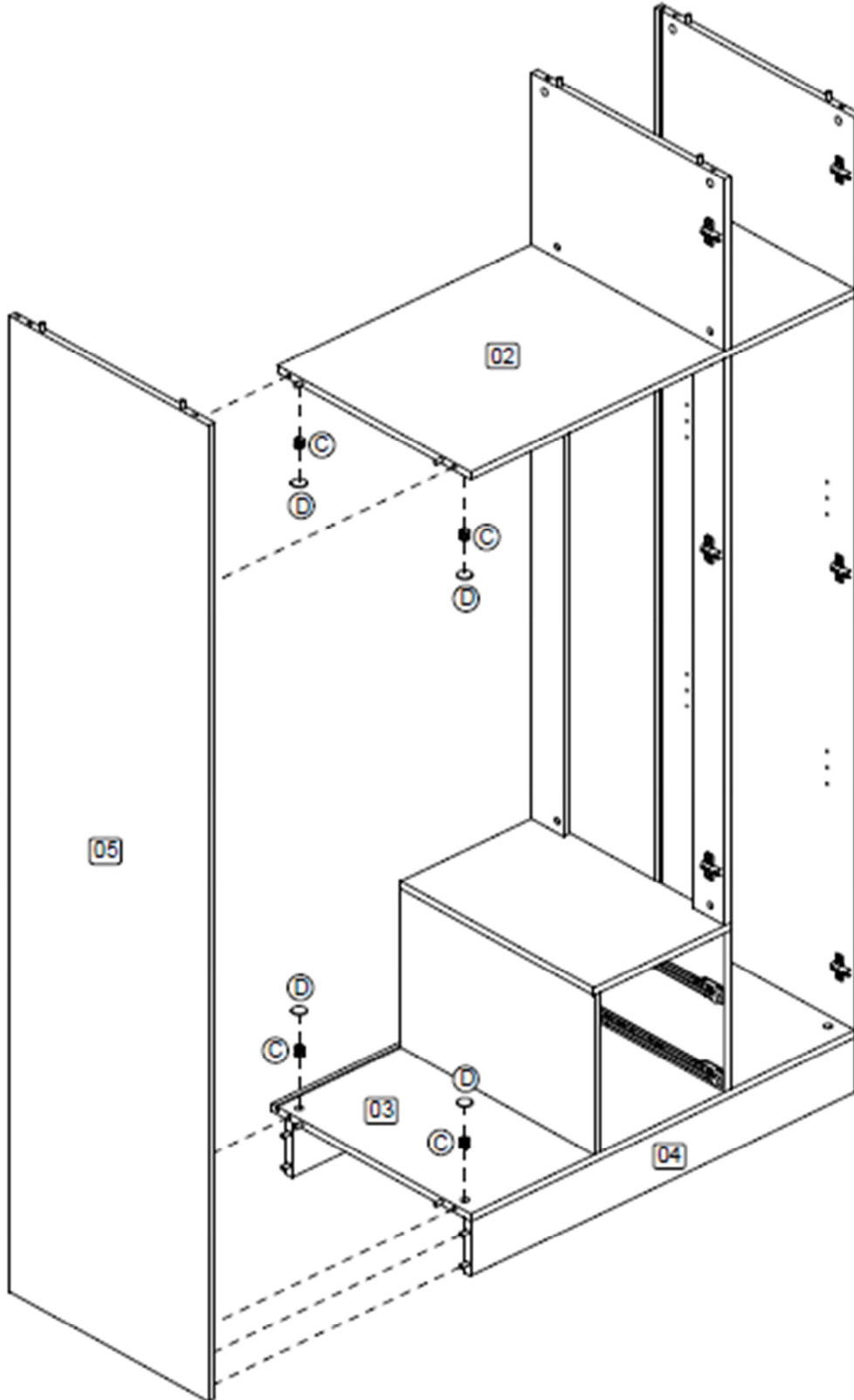

Step 8: Connect two back panels (10) with the spine (22) then position all of the back panels on the frame. Attach the top panel (1) using hardware parts C and D. Insert the shelves (20) using hardware parts M and T. You will need to use a screwdriver (not provided). DO NOT use any power tools as this may damage the frame and will invalidate any claim.

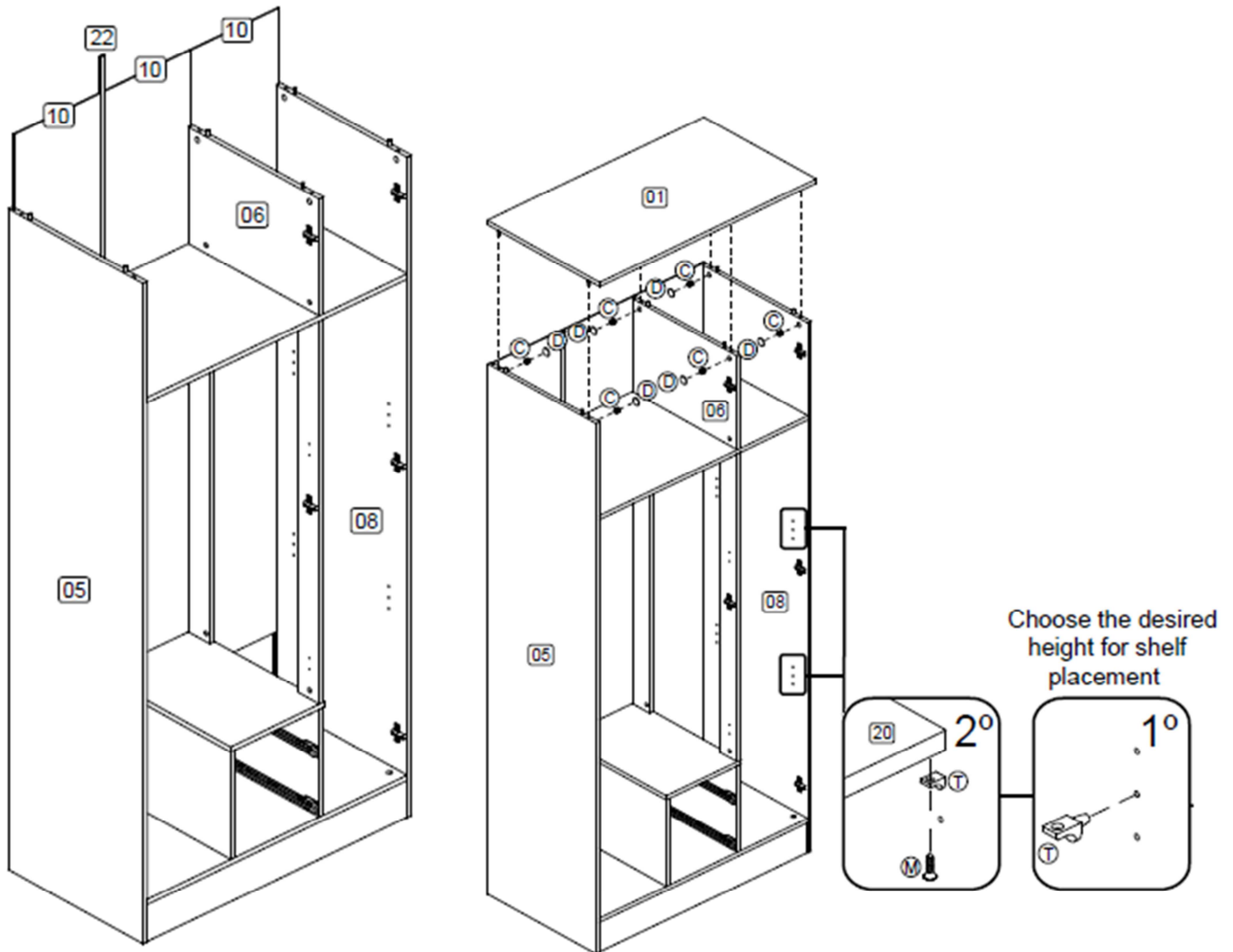

Step 9: Secure the back panels (10) using hardware parts I and Q with a small mallet (not provided) then position the hanging rail (23).

DO NOT use any power tools as this may damage the frame and will invalidate any claim

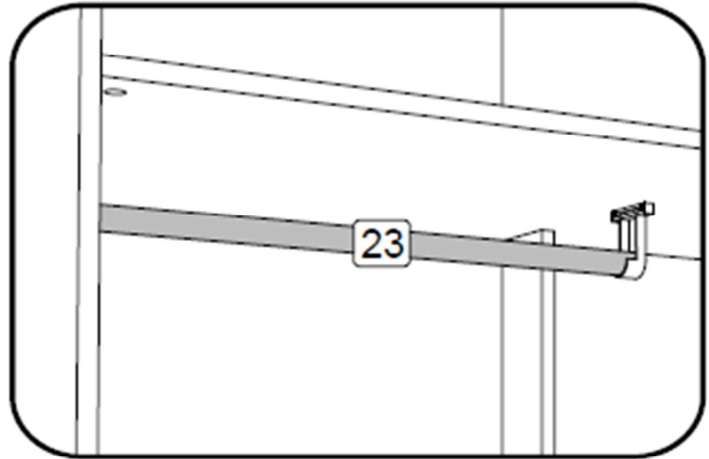
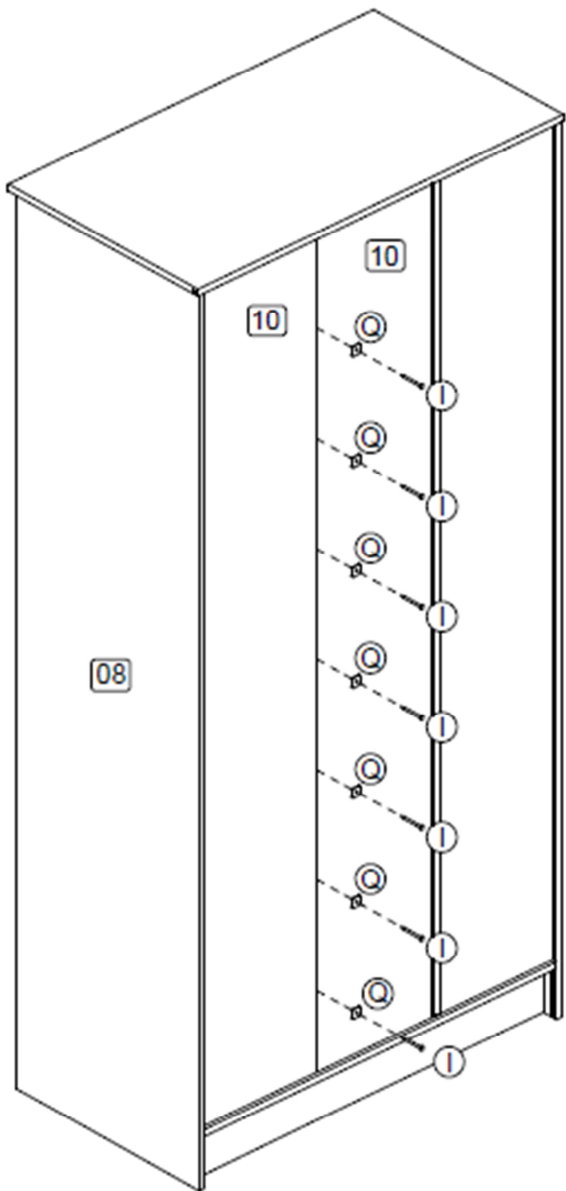

Step 10: Attach the doors (9) and the mirrored door (19) then attach the handles (24) using hardware part F. You will need to use a screwdriver (not provided).

DO NOT use any power tools as this may damage the frame and will invalidate any claim.

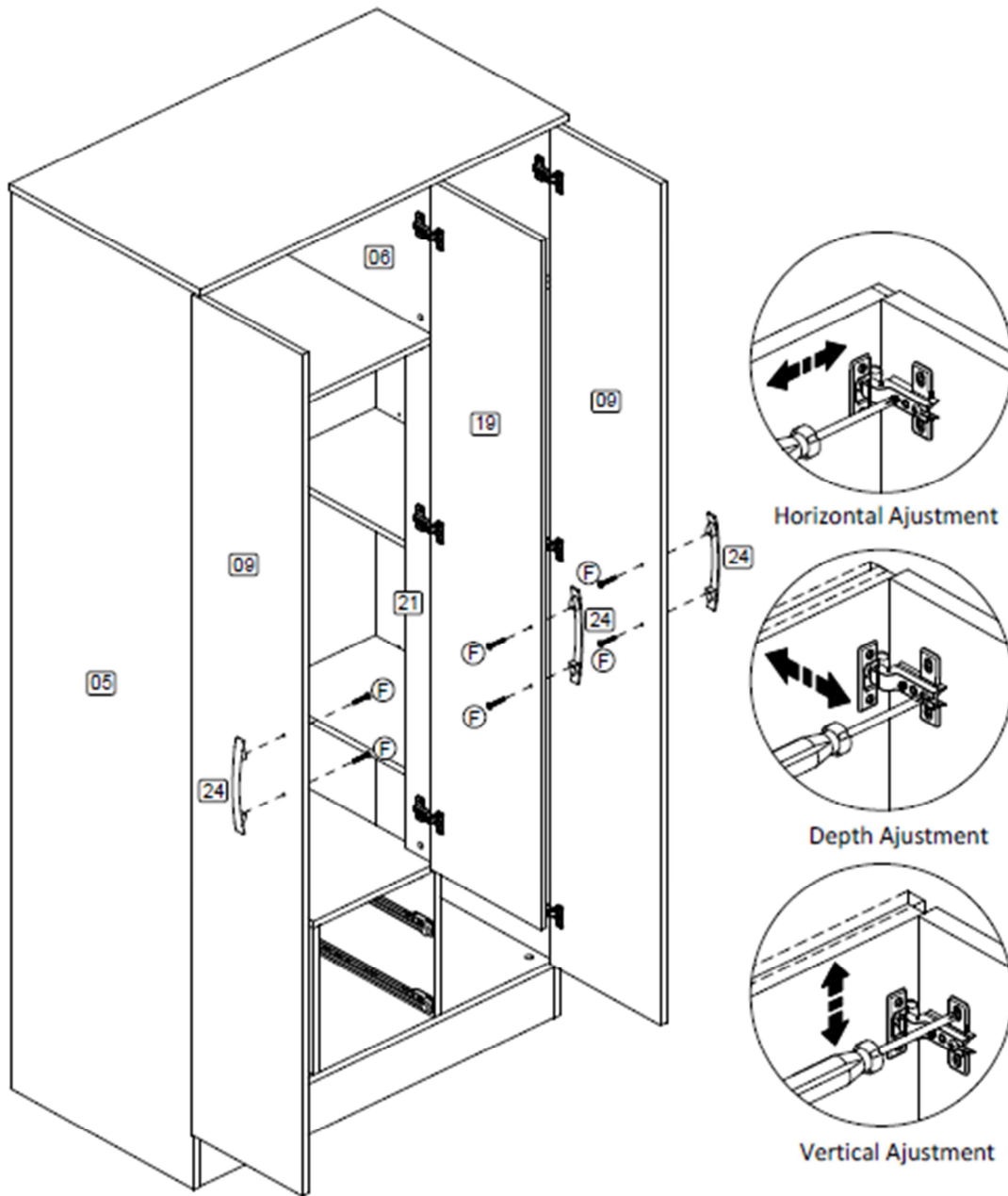

Step 11: Assemble the drawer components using hardware parts C, D, F, M, R and S with a screwdriver (not provided).

DO NOT use any power tools as this may damage the frame and will invalidate any claim.

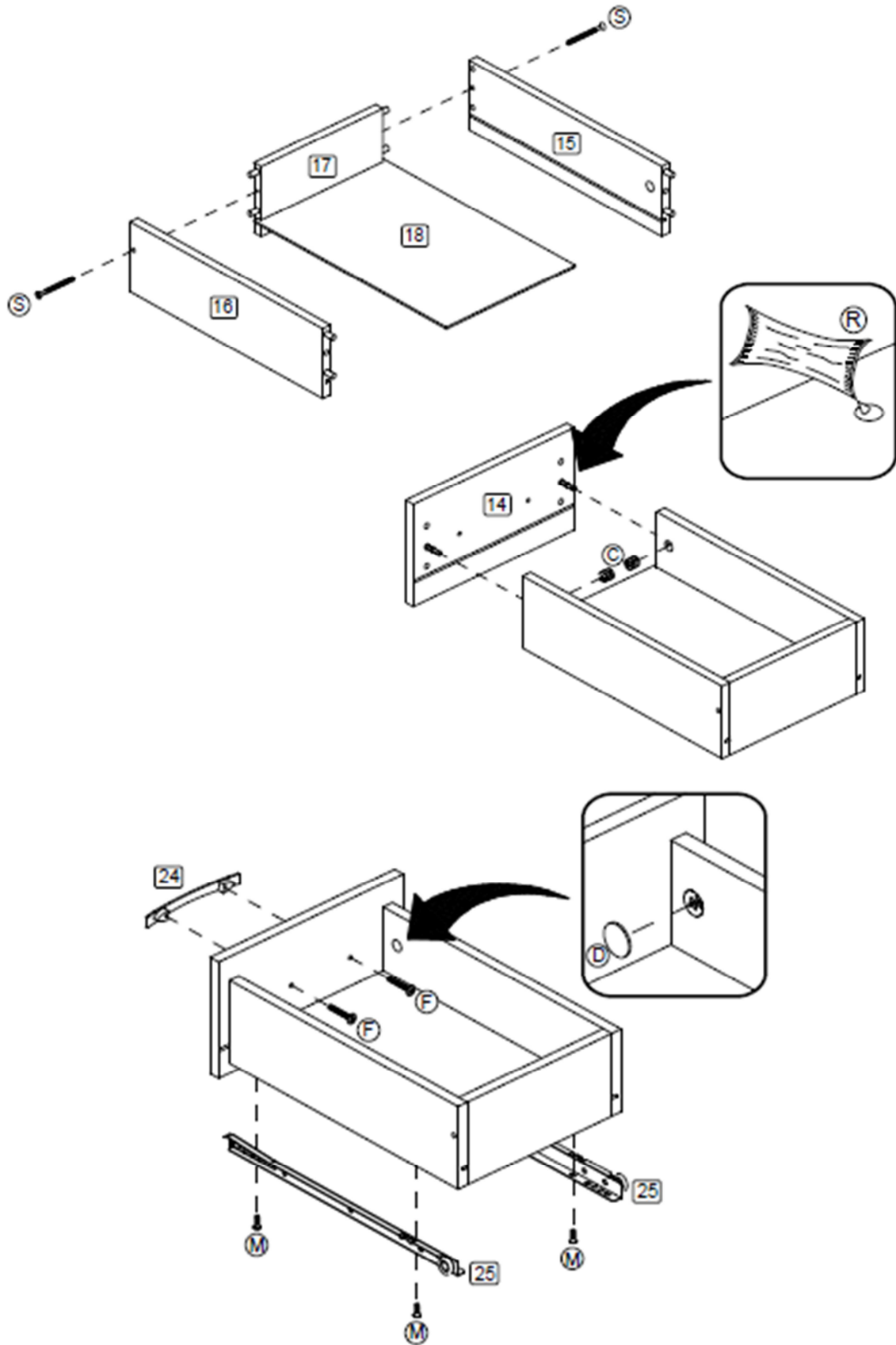

## Additional Information:

- For complete product information, images and dimension diagrams please visit the website [www.birlea.com](http://www.birlea.com)
- If you have any issues with your item please contact the retailer directly you purchased it from who will be able to resolve any issues with Birlea.
- Why don't you send us photos of your assembled furniture to [info@birlea.com](mailto:info@birlea.com) to be shared in our #birleahome feature on Instagram.

