

CROSLEY

CR7002A

Troubadour

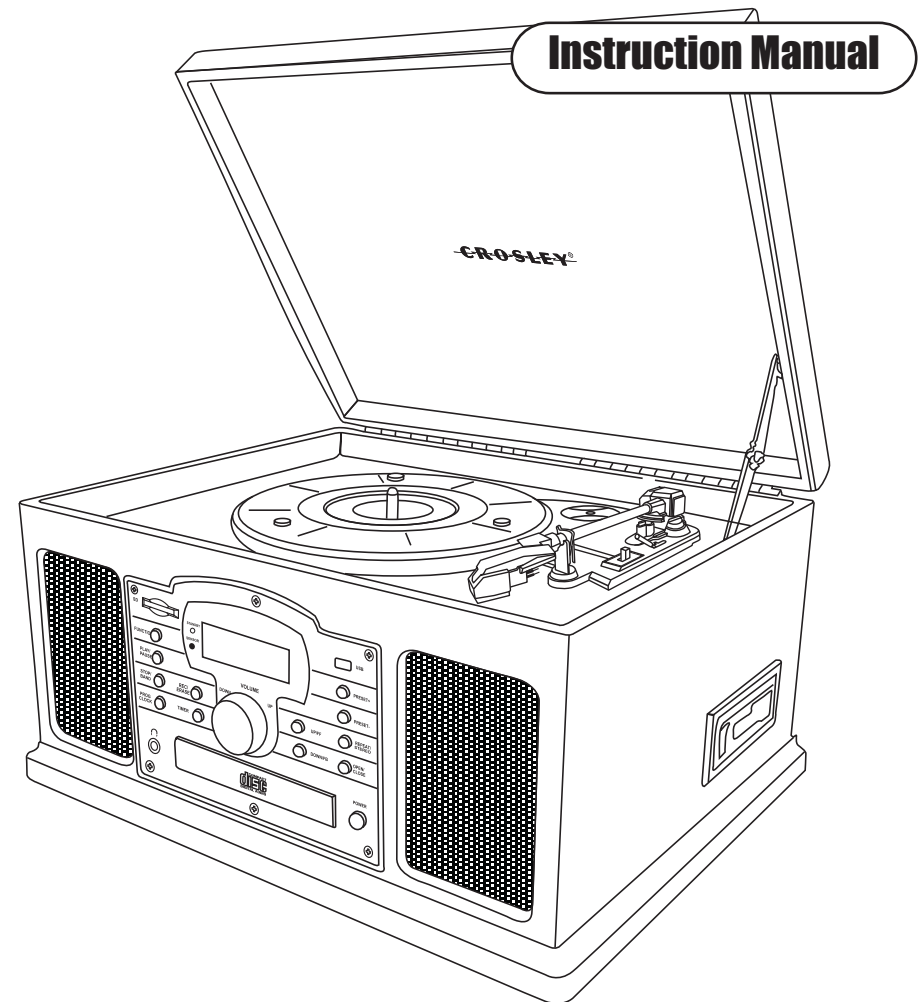

General

LIMITED MANUFACTURERS WARRANTY

Crosley Radio, Inc. warrants the product to be free from defects in material and workmanship under normal use for a period of one year from the original date of purchase. This warranty is not transferable. If the product is determined to be defective during the warranty period, the unit will be repaired or replaced at Crosley Radio's sole discretion. This warranty covers manufacturing defects and normal consumer use and does NOT cover damage or failure as a result of abuse, accident, alterations, misuse, neglect, abnormal wear and tear, inadequate maintenance, commercial or unreasonable use, damage caused by power surges, mishandling, accident, acts of God or attempted repair by an unauthorized service agent. Also not covered are cosmetic damages, cords and antennas.

Should this product fail to function in a satisfactory manner, it is best to first return it to the store or retailer where it was originally purchased. If additional service is still needed, the original purchaser must **FIRST** contact our offices to obtain an RA (Return Authorization) Number.

TO OBTAIN AN RA NUMBER
CALL: **1.888.CROSLEY**
(1.888.276.7539)

Send the unit prepaid to the address below in the original packaging (or reasonable substitute to prevent damage). Clearly mark your RA number on the outside packaging and include the original sales receipt (or a copy) indicating date of purchase, amount paid, and place of purchase. You must also include your full name, shipping address and daytime contact number. Please include a check or money order in the amount of \$19.95, made payable to Crosley Radio, to cover handling and return shipping charges. Returned products will not be shipped to PO Boxes. Crosley Radio will not be responsible for delays or unprocessed claims resulting from a purchaser's failure to provide any or all of the necessary information.

CROSLEY RADIO
ATTN: RETURNS DEPT
2001 PRODUCTION DRIVE
Louisville, KY 40299

For additional support: Crosley Radio Consumer Service Department
24 hours a day / 7 days a week
Telephone: 1.888.CROSLEY (1.888.276.7539)

*There are no express warranties except as listed above.
The purchaser's bill of sale is the only proof of warranty entitlement.*

This warranty gives the purchaser specified legal rights in addition to any rights which may vary from state to state.

In accordance with the "Moss-Magnuson Warranty Act" of July 10, 1975, this is termed a "limited warranty" which in no way compromises Crosley Radio's high standards of quality and workmanship.

IMPORTANT SAFETY INSTRUCTION

PLEASE READ CAREFULLY ALL THE FOLLOWING IMPORTANT SAFEGUARDS THAT ARE APPLICABLE TO YOUR EQUIPMENT

1. Read Instructions - All the safety and operating instructions should be read before the product is operated.
2. Retain Instructions - The safety and operating instructions should be retained for future reference.
3. Heed Warnings - All warnings on the product and in the operating Instructions should be adhered to.
4. Follow Instructions - All operating and use instructions should be followed.
5. Cleaning - Unplug this product from the wall outlet before cleaning. Do not use liquid cleaners or aerosol cleaners. Use a damp cloth for cleaning.
6. Attachments - Do not use attachments not recommended by the product manufacturer as they may cause hazards.
7. Water and Moisture - Do not use this product near water - for example, near a bath tub, wash bowl, kitchen sink, or laundry tub; in a wet basement; or near a swimming pool; and the like.
8. A product and cart combination should be moved with care. Quick stops, excessive force, and uneven surfaces may cause the product and cart combination to overturn.
9. Ventilation - Slots and openings in the cabinet are provided for ventilation and to ensure reliable operation of the product and to protect it from overheating, and these openings must not be blocked or covered. The openings should never be blocked by placing the product on a bed, sofa, rug, or other similar surface. This product should not be placed in a built-in installation such as a bookcase or rack unless proper ventilation is provided or the manufacturer's instructions have been adhered to.
10. Power Sources - This product should be operated only from the type of power source indicated on the marking label, if you are not sure of the type of power supply to your home. Consult your product dealer or local power company. For products intended to operate from battery power, or other sources, refer to the operating instructions.
11. Grounding or Polarization - This product may be equipped with a polarized alternating-current line plug (a plug having one blade wider than the other). This plug will fit into the power outlet only one way. This is a safety feature. If you are unable to insert the plug fully into the outlet try reversing the plug. If the plug should still fail to fit, contact your electrician to replace your obsolete outlet. Do not defeat the safety purpose of the polarized plug.
12. Power - Cord Protection - Power - supply cords should be routed so that they are not likely to be walked on or pinched by items placed upon or against them, paying particular attention to cords at plugs, convenience receptacles, and the point where they exit from the product.
13. Lightning - For added protection for this product during a lightning storm, or when it is left unattended and unused for long periods of time, unplug it from the wall outlet and disconnect the antenna or cable system. This will prevent damage to the product due to lightning and power - line surges.
14. Power Lines - An outside antenna system should not be located in the vicinity of overhead power lines or other electric light or power circuits, or where it can fall into such power lines or circuits. When installing an outside antenna system, extreme care should be taken to keep from touching such power lines or circuits as contact with them might be fatal.
15. Overloading - Do not overload wall outlets, extension cords, or integral convenience receptacles as this can result in a risk of fire or electric shock.
16. Object and Liquid Entry - Never push objects of any kind into this product through openings as they may touch dangerous voltage points or short - out parts that could result in a fire or electric shock. Never spill liquid of any kind on the product.
17. Servicing - Do not attempt to service this product yourself as opening or removing covers may expose you to dangerous voltage or other hazards. Refer all servicing to qualified service personnel.
18. Damage Requiring Service - Unplug this product from the wall outlet and refer servicing to qualified service personnel under the following conditions:
 - a. When the power-supply cord or plug is damaged.
 - b. If liquid has been spilled, or objects have fallen into the product.
 - c. If the product has been exposed to rain or water.
 - d. If the product does not operate normally by following the operating instructions. Adjust only those controls that are covered by the operating instructions as an improper adjustment of other controls may result in damage and will often require extensive work by a qualified technician to restore the product to its normal operation.
 - e. If the product has been dropped or damaged in any way.
 - f. When the product exhibits a distinct change in performance - this indicates a need for service.
19. Replacement Parts - When replacement parts are required, be sure the service technician has used replacement parts specified by the manufacturer or have the same characteristics as the original part. Unauthorized substitutions may result in fire, electric shock, or other hazards.
20. Safety Check - Upon completion of any service or repairs to this product, ask the service technician to perform safety checks to determine that the product is in proper operating condition.
21. Wall or ceiling Mounting - The product should be mounted to a wall or ceiling only as recommended by the manufacturer.
22. Heat - The product should be situated away from heat sources such as radiators, heat registers, stoves, or other products (including amplifiers) that produce heat.

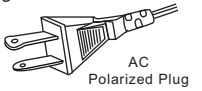

WARNING: Changes or modifications to this unit not expressly approved by the party responsible for compliance could void the user's authority to operate the equipment.

NOTE: This equipment has been tested and found to comply with the limits for a Class B digital device, pursuant to Part 15 of the FCC Rules. These limits are designed to provide reasonable protection against harmful interference in a residential installation. This equipment generates, uses, and can radiate radio frequency energy and, if not installed and used in accordance with the instructions, may cause harmful interference to radio communications. However, there is no guarantee that interference will not occur in a particular installation. If this equipment does cause harmful interference to radio or television reception, which can be determined by turning the equipment off and on, the user is encouraged to try to correct the interference by one or more of the following measures:

- Reorient or relocate the receiving antenna.
- Increase the separation between the equipment and receiver.
- Connect the equipment into a circuit different from that to which the receiver is connected.
- Consult the dealer or an experienced radio TV technician for help.

WARNING:

TO PREVENT FIRE OR SHOCK HAZARD, DO NOT EXPOSE THIS APPLIANCE TO RAIN OR MOISTURE. DO NOT REMOVE COVER. PILOT LAMPS SOLDERED IN PLACE. NO USER SERVICEABLE PARTS INSIDE. REFER SERVICING TO QUALIFIED SERVICE PERSONNEL.

 <p>The lightning flash with arrowhead symbol, within an equilateral triangle, is intended to alert user to the presence of uninsulated "dangerous voltage" within the product's enclosure that may be of sufficient magnitude to constitute risk of electric shock to persons.</p>	<div style="background-color: black; color: white; padding: 5px; font-weight: bold;"> CAUTION RISK OF ELECTRIC SHOCK DO NOT OPEN </div> <p>CAUTION: TO REDUCE THE RISK OF ELECTRIC SHOCK, DO NOT REMOVE COVER (OR BACK). NO USER - SERVICEABLE PARTS INSIDE. REFER SERVICING TO QUALIFIED SERVICE PERSONNEL.</p>	 <p>The exclamation point within an equilateral triangle is intended to alert user to the presence of important operating and maintenance (servicing) instruction in the literature accompanying the appliance.</p>
--	--	---

Specification

Frequency Range	: AM 520 - 1710 KHz : FM 87.5 - 108 MHz
USB Port 2.0	: Full Speed 512MB - 4GB (Support FAT16, FAT32)
Power Consumption	: 23W
Antennas	: External FM antenna wire : Built-in ferrite AM bar
Power Source	: AC Adaptor DC 12V,1000mA
Speaker Size	: 4" Dynamic type x 2
Speaker Ohm	: 4 Ohm
Speaker Watt	: 5W
Power Output	: 2W x 2
Replacement needle	: NP1

USB Specification

Interface

- USB 2.0 Full speed, HOST (USB HUB is not supported)
Corresponding Flash memory
- Compatible with MPEG Audio 1, 2, 2.5
- Compatible with Layer 1, 2, 3
- Compatible with Bit rate: 128 – 320 Kbps
- Subfolder nest : 8 levels
- Number of track / titles max 999
- Support ID3 tag V2.0

* DESIGN AND SPECIFICATIONS SUBJECT TO CHANGE WITHOUT NOTICE.

Troubleshooting

There is no power

- 1 Make sure radio is plugged in correctly.
- 2 Look at the STAND BY INDICATOR and check to see if it is red.
- 3 If the red light is on, press the **POWER** button /  to turn the unit on.

There is no sound

- 1 Make sure the mute function is turned off.
- 2 Check that the volume is turned up by pressing **VOLUME UP** button /  on the remote.

Note: Volume range on some units start at level 15 and ends at level 40.
- 3 Make sure INT./EXT. switch on back of radio is switched to INT. (Unless you are using external speakers, in which case it should be on EXT.)

- 4 Check to make sure power is turned on.

CD does not play

- 1 Check to make sure CD is inserted correctly (label side facing up).
- 2 Check to see that surface of CD is clean.
- 3 Make sure function switch is set to CD mode.

USB - There is no music playing when PLAY/PAUSE (USB) is pressed.

- 1 Make sure the MP3 device/Flash Drive has stored music files.
- 2 The unit will only play Flash Drives up to 512 – 4096 Bytes
- 3 Reset USB by switching the unit Off or switching to another Mode.
- 4 Check if the file(s) is WMA file(s). The unit does not play WMA format, only MP3 format.

Remote not working

- 1 Replace battery.
- 2 Be sure to point the remote towards remote sensor when operating.
3. Remove obstacles in the path of the remote and radio so the remote signal has a straight path to the radio.

Turntable will not work

- 1 Check it the AC Power source is connected.
- 2 Press the **POWER** button /  (on front of unit or on RC) to turn the unit on, the STAND BY INDICATOR light should be off.
- 3 Check that the unit is in PHONO Mode. Try moving the Tone Arm to the right until a click is heard.

No Sound is coming from the unit

- 1 The white protective needle cover has not been removed
- 2 The Volume is not turned up

The Tone Arm will not move

1. The black tie-wrap has not been removed from underneath Tone Arm .
2. Tone Arm hold down clip has not been released

Trademarks – MPEG Layer-3 audio coding technology licensed from Fraunhofer IIS and Thomson

Audio / Connections

AUX INPUT

Using the Aux Input allows you to hook up additional external audio components and listen to them through your unit. Any component with an audio output such as a Tuner, can be connected by using the correct cables (included). This unit uses standard RCA cables. Simply plug the red and white connectors on one end of the cable to the red and white Aux In jacks on the back of your unit. The other end of the cable will plug into the Audio Output jack on the external component. For more information on hooking up the external component, see the owner's manual for that component.

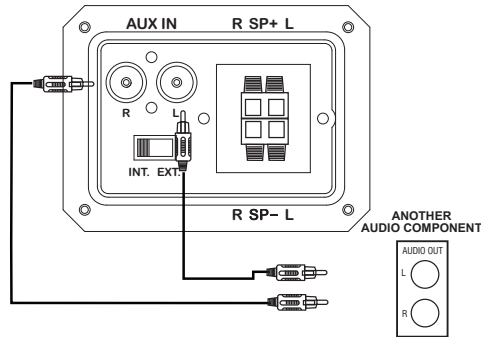

Headphones Jack Operation

- 1 Connect headphones to the Headphone Jack
- 2 Adjust volume to the desired listening level.

NOTE: When using headphones, the sound to the unit speakers will be cut off.

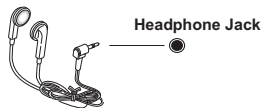

The sound from all speakers is cut off.

NOTE: Headphones not included with unit.

External Speaker Outputs

- 1 With your new unit, you have the option of adding external speakers.
- 2 The speaker jacks for external speakers are located on the back of the radio. Along with the speaker jacks is a switch labeled Int./Ext. When using external speakers, this switch must be switched to the EXT. position. Doing this turns off the internal speakers in the radio and redirects the power to the external speakers.
- 3 If you decide not to use the external speakers, be sure switch to INT.

Welcome

Thank you for purchasing the Crosley Troubadour (CR7002A). Before operating this unit, please read this manual thoroughly and retain it for future reference.

About This Manual

Instructions in this manual describe the control functions of the CR7002A.

Included in the package:

- Troubadour
- Remote Control
- RCA To 3.5mm Aux In Cable
- AC Power Adaptor
- 45 RPM Adaptor

Table of Contents

Getting Started

Unpacking.....	1
Power Source.....	1
Control Locators.....	2-3

Basic Operation

General.....	4-5
Radio Operation.....	6
Turntable Operation.....	7
Cassette Operation.....	7

CD Operation

Playing a CD.....	8
CD-MP3 disc playback.....	8
Programming Tracks.....	8

USB/SD Operation

USB/SD Operation.....	9
Recording	
Phono to USB/SD.....	9
Cassette to USB/SD.....	9
CD to USB/SD.....	10
Aux to USB/SD.....	10
MP3 copying.....	10

Audio / Connections

Aux Input.....	11
Headphone Jack Operation	11
External Speaker Outputs	11

General

Troubleshooting Guide.....	12
Warranty.....	13

Getting Started

Unpacking

- 1 Remove packing materials from unit.
Note: Save all packing materials
- 2 AC Adaptor and Remote Control are located on the outside of the Styrofoam packaging.
- 3 Remove plastic bag covering radio and remote control.
- 4 Untie antenna wire on back of radio.
- 5 Open lid and remove Styrofoam shipping material from turntable.
- 6 Remove black tie-wrap from under the TONE ARM
- 7 Remove white protective needle cover by gently pulling towards the front of the unit.

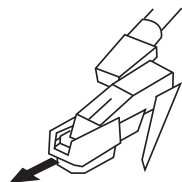



SET UP

- 1 Plug the small end of the AC adaptor into the DC jack on the back of unit and plug the adaptor into an appropriate outlet.
- 2 Untie the FM antenna and allow it to hang down in a straight line for optimum FM reception. If you have trouble tuning in an FM station, move the external FM antenna for best reception. Do not connect FM antenna to outside antenna.

Power Source

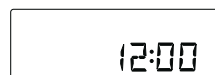
Connect the AC Adaptor to the wall socket. This system switches to Standby mode automatically and LCD would shown as below



To switch the unit on, press **POWER** /  LCD backlight will be turned on.
STANDBY LED is turned off and displayed as below.

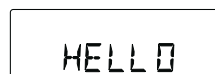

USB/SD Operation



- 2 Press **REC** /  to start ripping, the system will scan the contents of USB/SD card and create folder to store MP3 tracks.
- 3 Icon "REC" and message "RIPP TO" are displayed, icon "PHONO" start flashing.
- 4 The target device icon "USB" or "CARD" start flashing as ripping begins.



- 5 Press **STOP/BAND** /  to exit PHONO ripping

From CD TO USB/SD

The system is capable to convert whole CD disc to MP3 format and copy to USB mass storage device or SD card. And also have the ability to copy one single MP3 track to and from on USB/SD card.

- 1 In CD playback mode, press **REC** /  to start ripping to USB/SD card (default USB if both device are detected), playback will be stopped and skipped back to the beginning of current track, system will scan the contents of USB/SD card and create folder to store MP3 track. Resume CD playback and start ripping from the moment. The corresponding target device icon "USB" / "CARD" start flashing.
- 2 Press **STOP/BAND** /  to exit CD ripping.

From AUX To USB/SD

The system is capable to convert audio signal from AUX input to MP3 format and store in USB mass storage device or SD card (default USB if both devices are detected).

- 1 Press **FUNCTION** /  once or more to select AUX
- 2 Press **REC** /  to start ripping, the system will scan the contents of USB / SD card and create folder to store MP3 track.
- 3 Icon "REC" and message "RIPP TO" are displayed, icon "AUX" start flashing.



- 4 The target device icon "USB" or "CARD" start flashing as ripping begins.



- 5 Press **STOP/BAND** /  to exit AUX ripping

Note: The message "NO FUNCT" will be displayed if any key pressed during AUX ripping process. The message "NO DEV" will be shown if neither USB or SD card not detected. The message "FULL" will be displayed if not enough memory in target device.

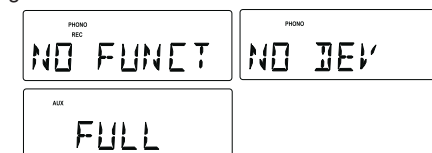

MP3 Copying

- 1 In CD-MP3, USB or SD card playback mode, press **REC** /  to start MP3 copying from CD to USB/SD card, or USB to SD card or vice versa. Playback will be stopped and system will scan the contents of USB/SD card and create folder to store MP3 track.
- 2 icon "REC" displayed
- 3 Message COPY 01 will be displayed, the proportional copied percentage will be shown on the decimal number.
- 4 The target device icon "USB" or "CARD" start flashing, the decimal number will be increment from 01 as MP3 copying starts, the process will stop as it reach 100
- 5 Current MP3 will be playback from beginning

Delete MP3 tracks

The system support deleting previous recorded MP3 or existing files.

- 1 In USB or SD card playback mode, press and hold **REC/ERASE** /  for 2 seconds, current playback track is stopped and will be deleted.
- 2 Message "delete" is displayed

USB/SD Operation

USB Playback

Follow the instructions below to play audio MP3 files stored on a USB Flash Drive.

- 1 Press the **FUNCTION** / to set the unit to USB mode.
- 2 Plug-in USB mass storage device. READ is displayed as the system scans the contents of USB device.



- 3 Track no. 1 of root folder (Folder 1) will be playback automatically after finish reading USB device contents.



- 4 Press **FF** / or **FB** / once or repeatedly until the desired track number appears in display.
- 5 Press **PRESET +** / or **PRESET -** / to select desired album.
- 6 Press **STOP/BAND** / to stop playback.

SD-CARD Playback

Follow the instructions below to play audio MP3 files stored on a SD-CARD.

- 1 Press the **FUNCTION** / to set the unit to CARD mode.



- 2 Insert SD-Card into the card slot. "READ" is displayed as the system scans the contents of SD card.
- 3 Track no. 1 of root folder (Folder 1) will be playback automatically after finish reading SD card contents.
- 4 Press **FF** / or **FB** / once or repeatedly until the desired track number appears in display.
- 5 Press **PRESET +** / or **PRESET -** / to select desired album.

- 6 Press **STOP/BAND** / to stop playback.

Notes:

- 1) USB connector does not support connection with USB extension cable .
- 2) This unit is not designed for communication with computer directly.
- 3) The unit may not work properly with all USB Flash Cards and SD-Cards.

IMPORTANT:

Do not disconnect the USB device during USB mode, as this may damage the external device or its files. Please power off first or press another Mode before safely disconnecting the USB device.

From Phono To USB/SD

The system is capable to convert audio signal from PHONO input to MP3 format and store in USB mass storage device or SD card (default USB if both devices are detected)

- 1 Press the **FUNCTION** / to set the unit to PHONO mode.



- 2 Press **REC** / to start ripping, the system will scan the contents of USB/SD card and create folder to store MP3 tracks.
- 3 Icon "REC" and message "RIPP TO" are displayed, icon "PHONO" start flashing.
- 4 The target device icon "USB" or "CARD" start flashing as ripping begins.

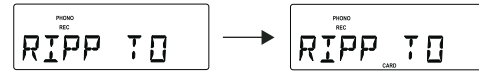

- 5 Press **STOP/BAND** / to exit PHONO ripping

From Cassette To USB/SD

The system is capable to convert audio signal from Cassette input to MP3 format and store in USB mass storage device or SD card (default USB if both devices are detected)

- 1 Press the **FUNCTION** / to set the unit to PHONO mode.



Control Locators

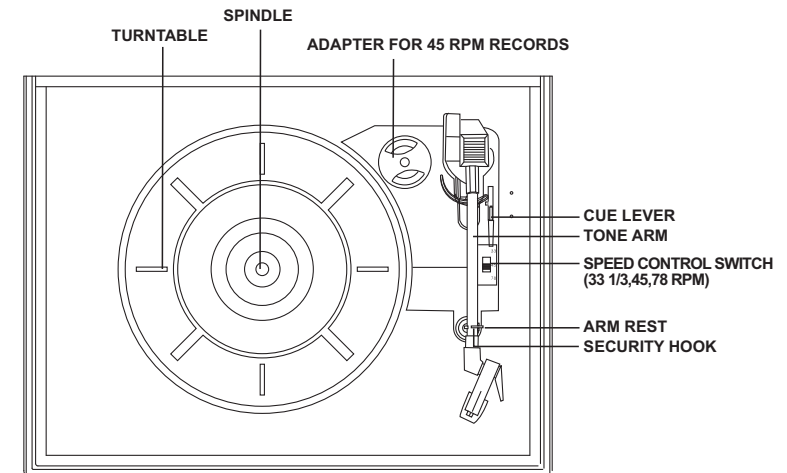
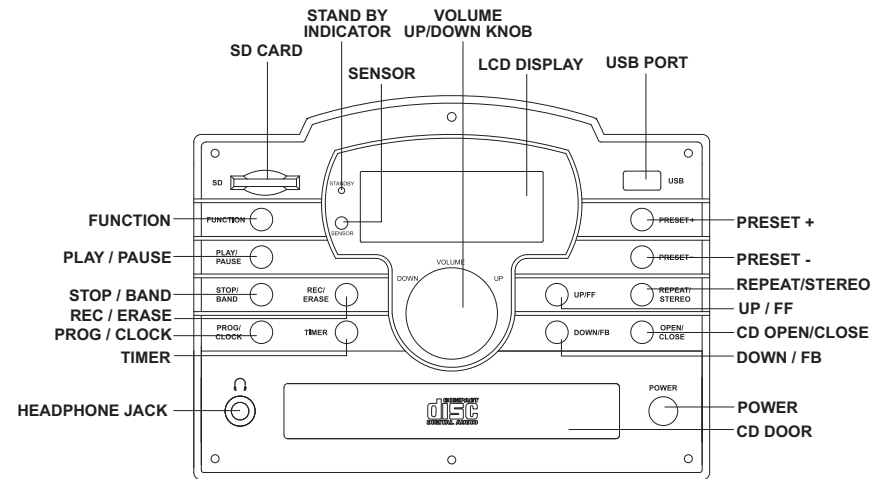
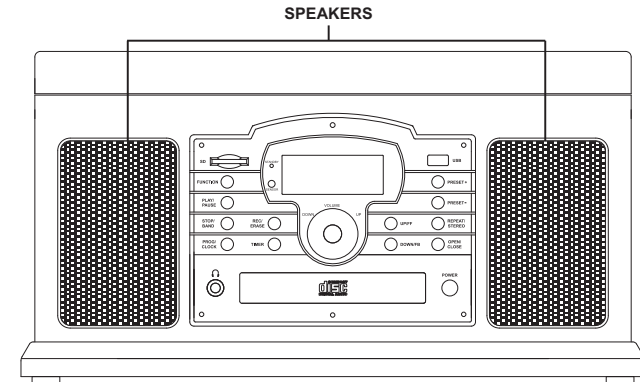

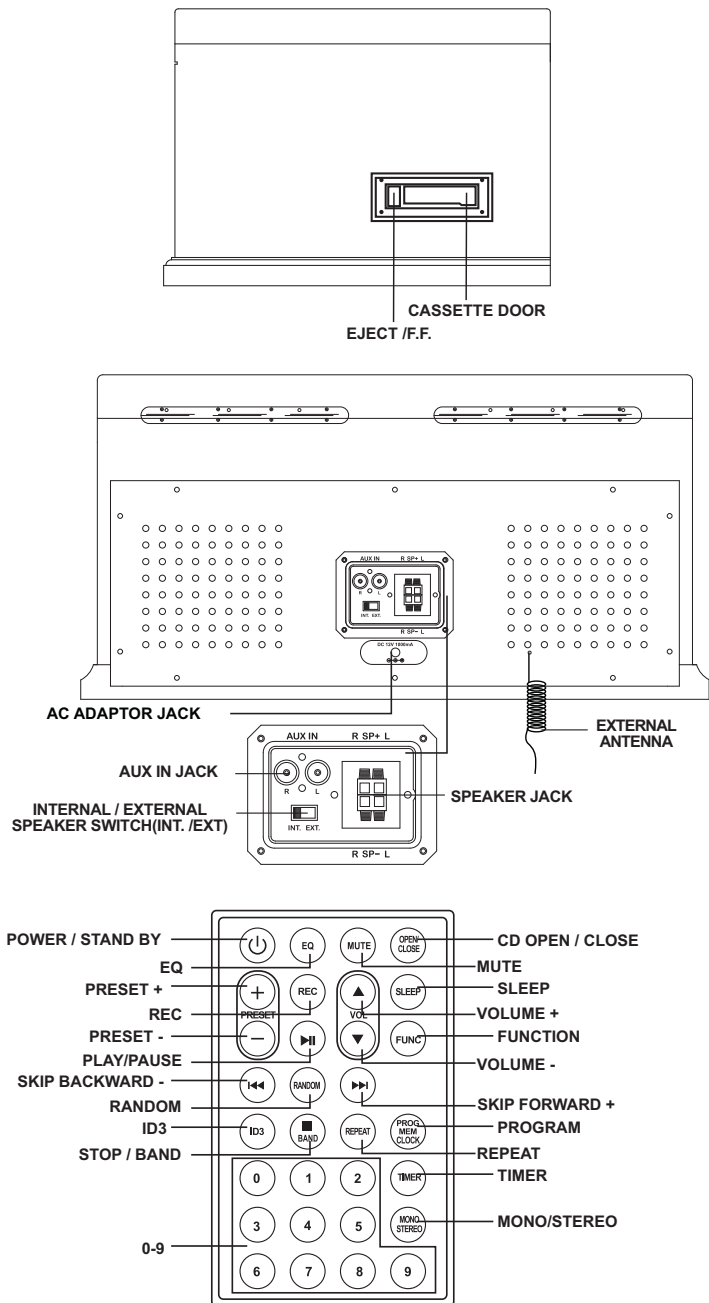

Playing a CD

- 1 Press the **FUNCTION / FUNC** to set the unit to CD mode.
- 2 Press **CD OPEN / CLOSE** to open the CD compartment
- 3 Insert a disc with the printed side facing up. Press **CD OPEN / CLOSE** again to close the compartment, **READ** is displayed as the CD player scans the contents of a disc.

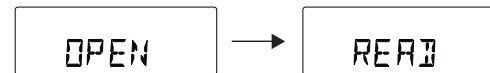

- 4 Track no. 1 will be playback automatically after finish reading CD disc contents.
- 5 Press **FF / FF** or **FB / FB** once or repeatedly until the desired track number appears in display.
- 6 Press **STOP/BAND** to stop playback.



Note: Icon "ESP" will flash for 40 seconds then state still.

- 4 Press **PRESET + / +** or **PRESET - / -** to select desired album.
- 5 Press **STOP/BAND** to stop playback.

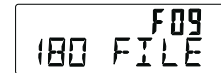

Programming Tracks

You may store up to 20 tracks in the desired sequence.

- 1 In the stop position, press **PROGRAM / MEM** to start programming. Icon "MEMORY" and P0-01 start flashing.



- 2 Press **FF / FF** or **FB / FB** once or repeatedly until the desired track number appears in the display. For MP3: press **PRESET + / +** or **PRESET - / -** to select the desired album.

- 3 Press **PROGRAM / MEM** to confirm, display shown stored track no. and next store position.



- 4 Repeat step 2-3 to select and store all desired tracks. **FULL** is displayed if you attempt to program more than 20 tracks



- 5 Press **PLAY/PAUSE / PAUSE** to play the program.

CD-MP3 disc playback

- 1 Insert CD-MP3 format disc. Press **CD OPEN / CLOSE** again to close the compartment. **READ** is displayed as the CD player scans the contents of a disc.



- 2 Track no. 1 of root folder (Folder 1) will be playback automatically after finish reading CD-MP3 disc contents.

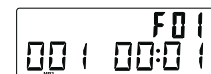

- 3 Press **FF / FF** or **FB / FB** once or repeatedly until the desired track number appears in display.

Erasing the program

You can erase the contents of the memory by:

- once if in stop position, twice during playback;
- Press **POWER / POWER**
- Select another sound source
- Open the CD door

Basic Operation

Turntable

PREPARING TO USE THE TURNTABLE

- 1 Lift up lid and remove black tie-wrap by untwisting and gently sliding out from TONE ARM .
- 2 Remove cardboard shipper.
- 3 Remove white protective needle cover by gently pulling towards front of unit.
- 4 Release TONE ARM and hold-down clip by gently pushing to the right. This will unlock tone arm from its ARM REST .Re-lock the hold-down clip when moving the unit to another location.

Turntable Operation



- 1 Press the **FUNCTION** /  to set the unit to PHONO mode.
- 2 Set the **SPEED CONTROL SWITCH** to the correct speed (33 1/3, 45 or 78 rpm) for the selected record.
- 3 Use the **CUE LEVER** to raise the **TONE ARM** off its rest. To start the record, move the **TONE ARM** to the right until you hear a "click". The turntable will start to turn.
- 4 Move the **TONE ARM** left and use the **CUE LEVER** to lower it to the point where you want the record to start.
- 5 At the end of the record, the **TONE ARM** will stop. You must return it to its rest by hand.

Accessory: ADAPTER FOR 45 RPM

To play a 45 rpm record, remove the adaptor by placing thumb & forefinger in recesses and pulling it upwards. Then placing it on the SPINDLE. The record can then be placed on the turntable.



Cassette Operation

- 1 Press the **FUNCTION** /  to set the unit to PHONO mode.
- 2 While in Phono mode, insert a prerecorded tape through the **CASSETTE DOOR**.
- 3 Adjust the volume level by turning the **VOLUME DOWN/UP KNOB** /  .
- 4 For fast forwarding, press the **EJECT/F.F.** half way in. Pressing again will stop the fast forwarding and return the cassette to the playing mode.
- 5 To stop and eject the cassette, press the **EJECT/F.F.** in completely.
- 6 When one side of the tape finishes playing, the cassette will automatically stop.

Note: 1. Remove the tape from the unit when it is not in use or stopped.
2. Phono function is disabled while a cassette is in use.

Basic Operation

Function Select

- 1 Press **FUNCTION** /  to select among:











- 2 When the unit is on, press **POWER** /  to switch the unit off. LCD backlight will be turned off and shown message "GOOD BYE" for 2 seconds, then the **STANDBY LED** is turned on.

GOOD BYE

Note: In the standby mode, EQ setting, sound settings tuner presets and the volume level (up to a maximum volume level of 30) will be stored in the unit's memory.

Setting The Clock

After connecting the system to power supply, set the clock first.



- 1 Press **POWER** /  to switch the unit to Standby mode.
-The display shows the time
-"0:00" flashes by default if you have not set the clock
- 2 In the Standby mode, press and hold **PROGRAM** /  over 1 second.
-The hours digit starts flashing
- 3 Press the **FF** /  or **FB** /  repeatedly to set the hours.
- 4 Press **PROGRAM** /  again to confirm.
The minutes digit starts flashing
- 5 Hold down **FF** /  or **FB** /  repeatedly to set the minutes.
- 6 Press **PROGRAM** /  again to confirm.
The minutes digit stop flashing, the clock begins to run.
- 7 Press **PROGRAM** /  to select between 12 and 24 hours, shown as below

0:00

AM 12:00







Setting the Timer

The unit can be used as an alarm clock, whereby the selected source (CD, TUNER, USB, SD CARD OR PHONO) to start playback at a preset time. Make sure the clock is set before using the timer.







- 1 In the standby mode, press and hold **TIMER** /  over 1 second, icon "⌚" and message "TURN ON" start flashing. Press **TIMER** /  again to begin the "SYSTEM POWER ON" timer setting.

TURN ON

18:00

- 2 Press **FF** /  or **FB** /  repeatedly to set hours.
- 3 Press **TIMER** /  to enter minutes setting mode.
- 4 Press **FF** /  or **FB** /  repeatedly to set minutes.
- 5 Press **TIMER** /  again to begin "SYSTEM POWER OFF" timer setting.
Icon "⌚" and message "TURN OFF" start flashing. Press **TIMER** /  again to begin timer setting.

TURN OFF

- 6 Press **FF** /  or **FB** /  repeatedly to set hours.
- 7 Press **TIMER** /  on the remote to enter minutes setting mode.
- 8 Press **FF** /  or **FB** /  repeatedly to set minutes.
- 9 Press **TIMER** /  again to begin setting the source from wake up.
Default at TUNER mode. Message TUNER start flashing.

TUNER

- 10 Press **FUNCTION** /  to select wake up source. The unit will be waked up from last tuned station if TUNER mode is selected.



Basic Operation

11 Press **TIMER** / on the remote again to complete timer on/off setting. Icon "⌚" will keep display on LCD if timer is set.

Note: The wake up sound level will be increased gently to preset volume level.

12 Press **TIMER** / on the remote control to turn on/off the timer. The icon "⌚" will be on/off respectively.

Mute

You can temporarily switch off the sound without switching off the unit.

- 1 Press **MUTE** / on the remote control to switch off the sound, playback continues without sound.
- 2 To switch on the sound, you can:
 - press **MUTE** / again;
 - adjust the volume controls;
 - change source



EQ

Press **EQ** / on the remote control to select desired EQ mode.
5 modes preset EQ:

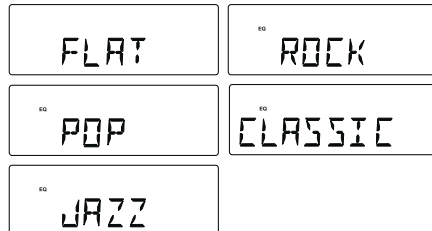

Sleep

Sleep mode allows the unit to operate for a pre-set amount of time, and then automatically turns off.

On the remote control, press **SLEEP** / repeatedly to select the desired time period options (in minutes):

- Display shows in sequence: SLEEP 90, 80, 70, 60, 50, 40, 30, 20, 10
- Display shows the selected option briefly and returns to its previous status.

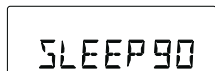

To deactivate the sleep timer, press **SLEEP** / again to "00" or Press **POWER** / to switch the unit into standby mode.

Basic Operation

AM/FM Tuning

- 1 Press the **FUNCTION** / to set the unit to TUNER mode.
- 2 Press **STOP/BAND** / repeatedly to select your desired waveband. FM or AM

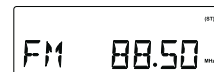

- 3 Auto Tuning – Press and hold **FF** / or **FB** / until stations begin to scan. The unit will automatically tune to the first available station with sufficient reception. If a station is received in stereo, (ST) will show on the display. Repeat step 3 if necessary until you find your desired station.
- 4 Manual Tuning – Press **FF** / or **FB** / briefly and repeatedly until found a station.

Programming Radio Stations

You can store up to a total of 40 radio stations (20 FM and 20 AM) in the memory, manually or automatically (Autostore)

- 1 Tune to your desired station
- 2 Press **PROGRAM** / to activate programming, icon "MEMORY" and P01 will start flashing.

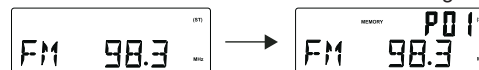

- 3 Press **PRESET +** / or **PRESET -** / to allocate a number from 1 to 20 stations.



- 4 Press **PROGRAM** / to confirm, display shows the preset number waveband and the frequency of the preset station.
- 5 Repeat steps 1-4 to store other stations to listen to a preset station. Press **PRESET +** / or **PRESET -** / once or more until the desired preset station in displayed.

To listen to a preset station

Press **PRESET +** / or **PRESET -** / once or more until the desired preset station in displayed. Automatic programming radio stations Automatic programming will station preset 1, from this preset number upwards, former programmed tuner stations will be erased.

- 1 Press and hold **PROGRAM** / button until Auto appears
- Icon "memory" will start flashing



- Available stations are programmed.

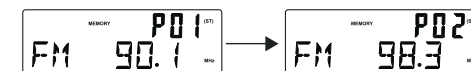

- After all stations are stored, the last preset station will then be played.

ANTENNA

Antenna: for FM reception, the unit is provided with a FM WIRE ANTENNA, move the wire until the reception is clear and with no interferences. For AM reception, the unit is provided with a directional build-in ferrite antenna. Rotate the set to find the position in which the best reception is obtained. Do not connect the EXTERNAL FM ANTENNA to any outside antenna.